

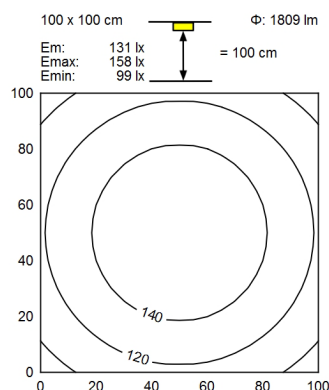

light source	LED
connected load	110 - 277V; 50/60Hz
Power consumption	approx. 25 W
luminous flux	approx. 1800 lm
luminous efficacy	approx. 74 lm/W
light distribution	360° light output
color temperature	neutral white, approx. 5000 K
color rendering index (CRI)	>= 95
System of protection	IP67
class of protection	I
technology	0-10V dimming
operation	build in power supply
luminaire body	acrylic, opal
weight (net)	approx. 1.8 kg (4 lb)
mains supply	8 ft cord
Fastening	suspended, vertical bracket and canopy kit (included)
fastening length	84" suspension aircraft wire
dimension	A = 955 mm (37.59 in)
light output	D = 765 mm (30.1 in)
outside diameter	70 mm (2.75 in)
side part	with screwed cable gland
special features	suitable for wet locations
max ambient temperature	40C (104F)



illuminance



luminous intensity

