

DLite® amadea Bed 39/39 W - D14796001

TECHNICAL DATA

ROOM LIGHTS

FITTED WITH 2 x fluorescent lamp T5 39 W - D68891000

LIGHT DISTRIBUTION general lighting; indirect 39 W
examination lighting; indirect/direct 2x39 W

WORK EQUIPMENT electronic ballast, low voltage controller

CONNECTED LOAD 277V; 50-60 Hz

MAINS LEAD direct power supply

LUMINAIRE BODY aluminium powder-coated

WEIGHT (NET) approx. 6,3 kg (13.9 lbs)

POWER CONSUMPTION approx. 90 W

USAGE without switch

LAMP COVER Acrylic satine

TECHNOLOGY single switchable

CLASS OF PROTECTION I

NORMS EN 60598-1, EN 60598-2-25

SPECIAL FEATURES DRS Double-Reflector-System

FASTENING wall mount



LIGHT DISTRIBUTION

TECHNICAL DRAWING

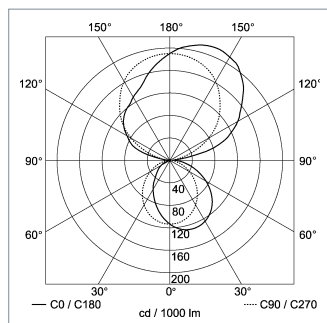

Dimensions in cm.

