

Dmed® triango 30 C Spec Sheet
D15-170-130 DERUNGS 900MM

Electrical:

Nominal input voltage	100-120V / 200-240V
Frequency range	50 / 60Hz
Power consumption	30W (42-52VA)
Input current	0.42A
Integrated electronic transformer	24V DC output
Approval - Safety	ETL/cETL
User interface	Continuously dimmable rotary switch on the head

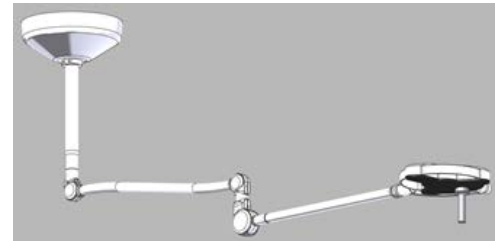

Illumination:

Fitted with	LED Technology
Central illuminance at 1.0m	55,000 lux
Light field diameter d10 at 1.0m	Ø = 16 cm (6.3in)
Light field diameter d50 at 1.0m	Ø = 8.5 cm (3.3in)
Depth of illumination L1 + L2	120cm (47.24in)
Color Temperature	4500 K
Color Rendering Index Ra	>95
Life time	30000h

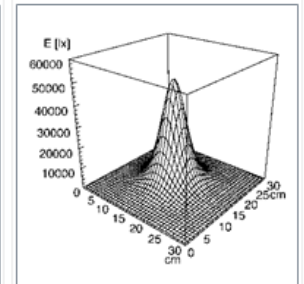
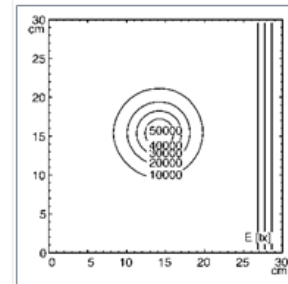

Weight:

Light head	3 kg (6.6lbs)
triango 30 C (includes light head)	15 kg (33lbs)
triango 30 F (includes light head)	15 kg (33lbs)
Luminaire Materials	Head – polycarbonate & acrylonitrile butadiene styrene copolymer (PC &ABS); Arm – metal
Fastening	Ceiling mount to structural ceiling, tube can be field cut to length (150-900 mm)

Classification:

triango 30	Class I; FDA Class II
Degree of protection as per IEC 529	IP 20
Light head	IP 43 (horizontal position)
Electrical safety test according to:	AAMI ES60601-1, CSA C22.2#60601-1, IEC/EN 60601-1, IEC/EN 60601-2-41, IEC/EN 60601-1-2
Special feature	Removable Sterilizable Handle included

Component List - Included

#	Part Number	Description
1	US4-001-205	Mounting Adapter 13.3 in.
2	Call Factory	Mounting Plate 13.3 in.
3	US4-001-400	Dome Cover
4	US4-001-500	Collar, 2 piece with screws
5	US4-001-330	Pole, 900MM Length
6	D74-544-100	Spring Balanced Arm
7	D15-353-000	Head, Triango 30, 24V, LED
Additional Information Available (Manuals)		
1	Call Factory	Triango Pre-Install Guide
2	Included	Triango Manual
3	Call Factory	Triango Spare Parts Manual

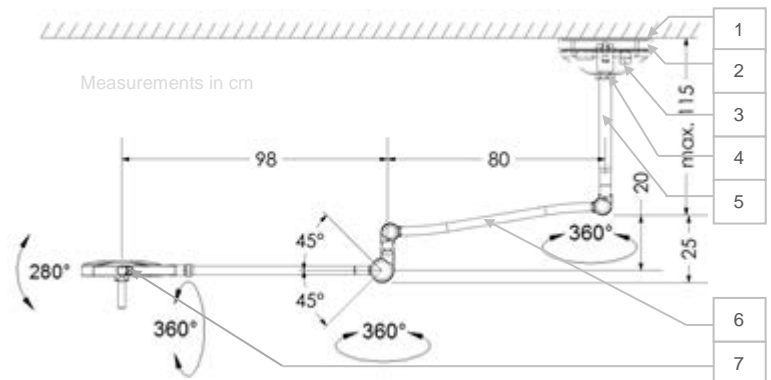

NOTE: If fixture is to be installed above a drop ceiling, Additional items 3 and 4 must be ordered separately. Please refer to Triango Pre-Install Guide for installation suggestions.