

**HEADQUARTERS GERMANY**

Herbert Waldmann GmbH & Co. KG  
Postfach 50 62  
78057 VILLINGEN-SCHWENNINGEN  
GERMANY  
Telephone +49 7720 601-100  
Fax +49 7720 601-290  
www.waldmann.com  
info@waldmann.com

**FRANCE**

Waldmann Eclairage S.A.S.  
Zone Industrielle  
Rue de l'Embranchement  
67116 REICHSTETT  
FRANCE  
Telephone +33 3 88 20 95 88  
Fax +33 3 88 20 95 68  
www.waldmann.com  
info-fr@waldmann.com

**ITALY**

Waldmann Illuminotecnica S.r.l.  
Via della Pace, 18 A  
20098 SAN GIULIANO MILANESE (MI)  
ITALY  
Telephone +39 02 98 24 90 24  
Fax +39 02 98 24 63 78  
www.waldmann.com  
info-it@waldmann.com

**THE NETHERLANDS**

Waldmann BV  
Lingewei 19  
4004 LK TIEL  
THE NETHERLANDS  
Telephone +31 344 631019  
Fax +31 344 627856  
www.waldmann.com  
info-nl@waldmann.com

**AUSTRIA**

Waldmann Lichttechnik Ges.m.b.H.  
Gewerbepark Wagram 7  
4061 PASCHING/LINZ  
AUSTRIA  
Telephone +43 7229 67400  
Fax +43 7229 67444  
www.waldmann.com  
info-at@waldmann.com

**SWEDEN**

Waldmann Ljusteknik AB  
Skebokvarnsvägen 370  
124 50 BANDHAGEN  
SWEDEN  
Telephone +46 8 990 350  
Fax +46 8 991 609  
www.waldmann.se  
hk@waldmann.se

**SWITZERLAND**

Waldmann Lichttechnik GmbH  
Benkenstrasse 57  
5024 KÜTTIGEN  
SWITZERLAND  
Telephone +41 62 839 1212  
Fax +41 62 839 1299  
www.waldmann.com  
info-ch@waldmann.com

**UK**

Waldmann Lighting Ltd.  
Holme Well Road  
Middleton  
LEEDS LS 10 4TQ  
WEST YORKSHIRE  
UK  
Telephone +44 113 2775662  
Fax +44 113 2775775  
www.waldmann.com  
enquiries@waldmannlighting.co.uk

**USA**

Waldmann Lighting Company  
9, W. Century Drive  
WHEELING, ILLINOIS 60090  
USA  
Telephone +1 847 520 1060  
Fax +1 847 520 1730  
www.waldmannlighting.com  
waldmann@waldmannlighting.com

**CHINA**

Waldmann Lighting Shanghai Pte. Ltd.  
Part A, No. Five Normative Workshop  
199 Changjian Road, Baoshan  
SHANGHAI, P.R.C. 200949  
CHINA  
Telephone +86 21 5169 1799  
Fax +86 21 3385 0032  
www.waldmann.com  
s.lo@waldmann.com.cn

**SINGAPORE**

Waldmann Lighting Singapore Pte. Ltd.  
168, Jalan Bukit Merah, #04-09B,  
Connection One, Tower 3,  
SINGAPORE 150168  
SINGAPORE  
Telephone +65 6275 8300  
Fax +65 6275 8377  
www.waldmann.com  
sales@waldmann.com.sg

**Waldmann** **W**  
ENGINEER OF LIGHT.

EN

ATARO | INDIRECT LIGHTING FAMILY

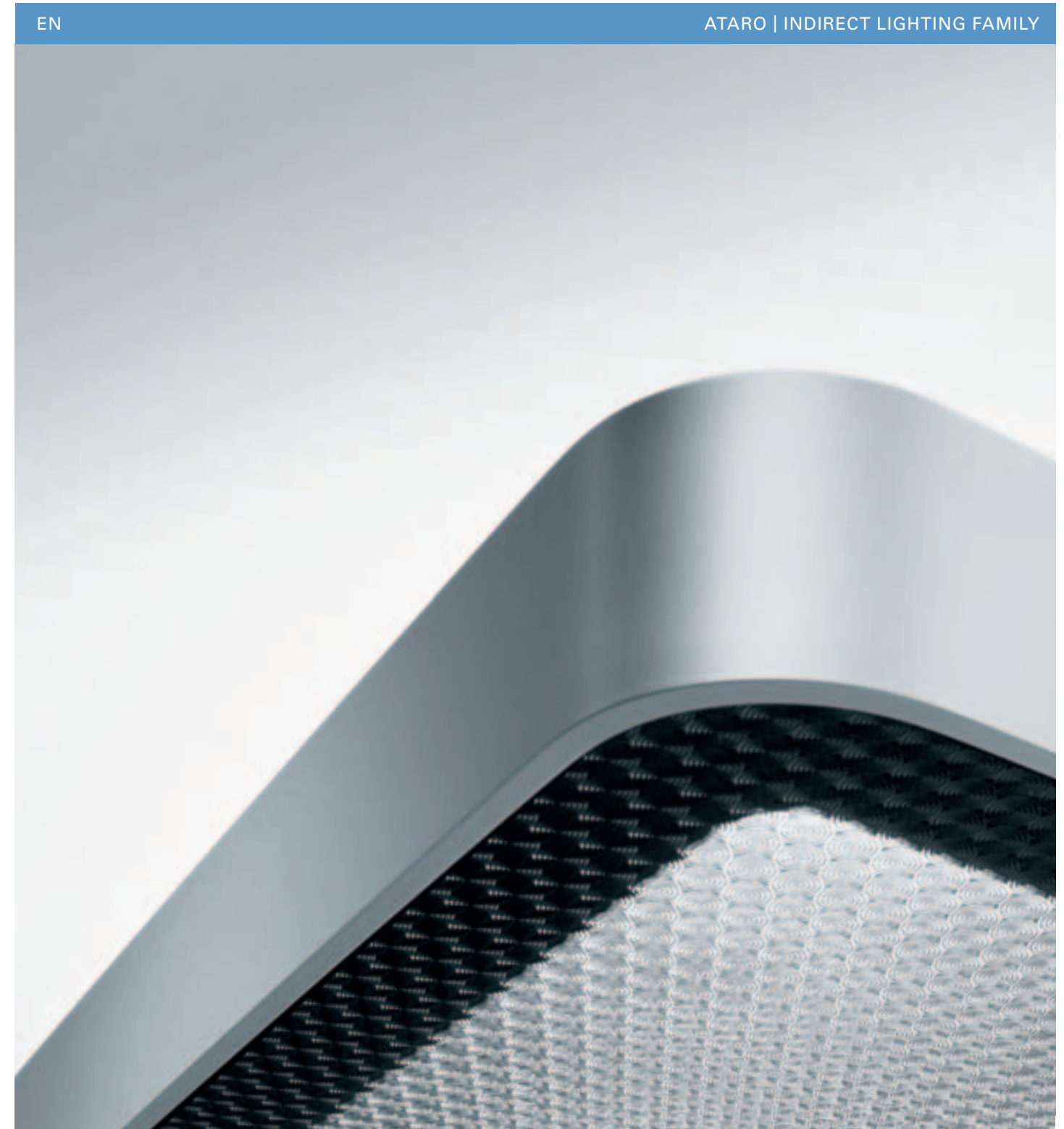

www.waldmann.com



# TECHNICAL DATA

## ATARO FREE-STANDING AND TABLE-MOUNTED LUMINAIRE 2-TUBE

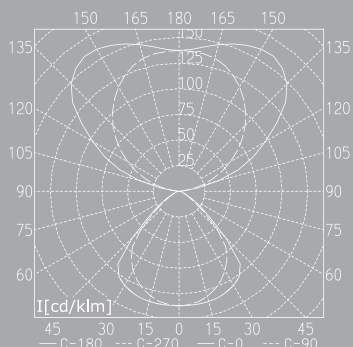

Free-standing/table-mounted luminaires

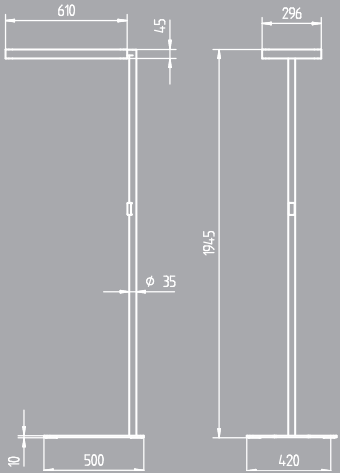

Free-standing luminaires

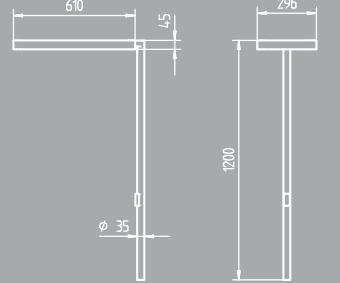

Table-mounted luminaires

POWER SUPPLY	230– 240V; 50/60 Hz
FITTED WITH	2 x compact fluorescent lamps TC-L 40W
WORK EQUIPMENT	Electronic ballast
POWER CONSUMPTION	approx. 83W
MAINS CONNECTION	approx. 3 m; shock-proof plug
HOUSING MATERIAL	Anodized aluminum
LOWER ARM	Painted Steeltube
FOOT	Steel plate rectangular, flat, painted
OPERATION	Multi-function switch in tubular section
OPERATING EFFICIENCY	74 %
LIGHT DISTRIBUTION	Symmetrical; direct light portion approx. 30 %
DIFFUSION	Light-amplifying AMBIO microprism, average luminance on reflector according to EN 12464-1 requirements
LAMP COVER	None

### SPECIAL FEATURES

- Integrated PULSE HFMD (high-frequency technology) or PULSE PIR (passive infrared technology) light- and presence-detecting sensors
- Sensitive response; pleasant, inconspicuous control and dimming behaviour thanks to appropriate impulse delay and asymmetrical dimming
- Individually adjustable lighting level
- Easy-to-reach multifunctional operating element. (Can be connected to switched power sockets.)
- Luminaire head can be pivoted by +/- 90°
- Removable prism disk for easy replacement of lamps and simple cleaning

FREE-STANDING LUMINAIRES	TYPE	EQUIPPED WITH	ORDER NO. WHITE	ORDER NO. CHAMPAGNE
Free-standing luminaire switchable	DUS 240	2 x 40W	121 209 001	121 209 000
Free-standing luminaire dimmable	DUS 240/D	2 x 40W	121 210 001	121 210 000
PULSE PIR free-standing luminaire	DUS 240/R	2 x 40W	121 211 001	121 211 000
PULSE HFMD free-standing luminaire	DUS 240/P	2 x 40W	121 212 001	121 212 000

TABLE-MOUNTED LUMINAIRES	TYPE	EQUIPPED WITH	ORDER NO. WHITE	ORDER NO. CHAMPAGNE
Table-mounted luminaire switchable	DUT 240	2 x 40W	121 537 001	121 537 000
Table-mounted luminaire dimmable	DUT 240/D	2 x 40W	121 538 001	121 538 000
PULSE PIR table-mounted luminaire	DUT 240/R	2 x 40W	121 539 001	121 539 000
PULSE HFMD table-mounted luminaire	DUT 240/P	2 x 40W	121 540 001	121 540 000

ACCESSORIES	ITEM	ORDER NO.
Table-mounted luminaires	Table clamp stone gray, Span 20-28mm	191 102 059
	(Other adaptations available on request)	

## DESIGN, ENGINEERING SKILL AND LIGHTING TECHNOLOGY AT EYE LEVEL.

ATARO is the new indirect lighting family in which maximum aesthetics, material quality and novel, intuitive ease of operation as well as intelligent lighting technology and maximum energy efficiency perfectly complement each other like never before.

ATARO makes a clear statement of good design with its unobtrusive style and premium materials, as well as the indiscernible material transition.

In addition, ATARO, with its state-of-the-art technology and unique light management system, is also the new light form when it comes to energy efficiency.

Due to its innovative AMBIO glare-free technology, ATARO produces a lighting quality that outshines all conventional indirect luminaires, using 30 % less energy.

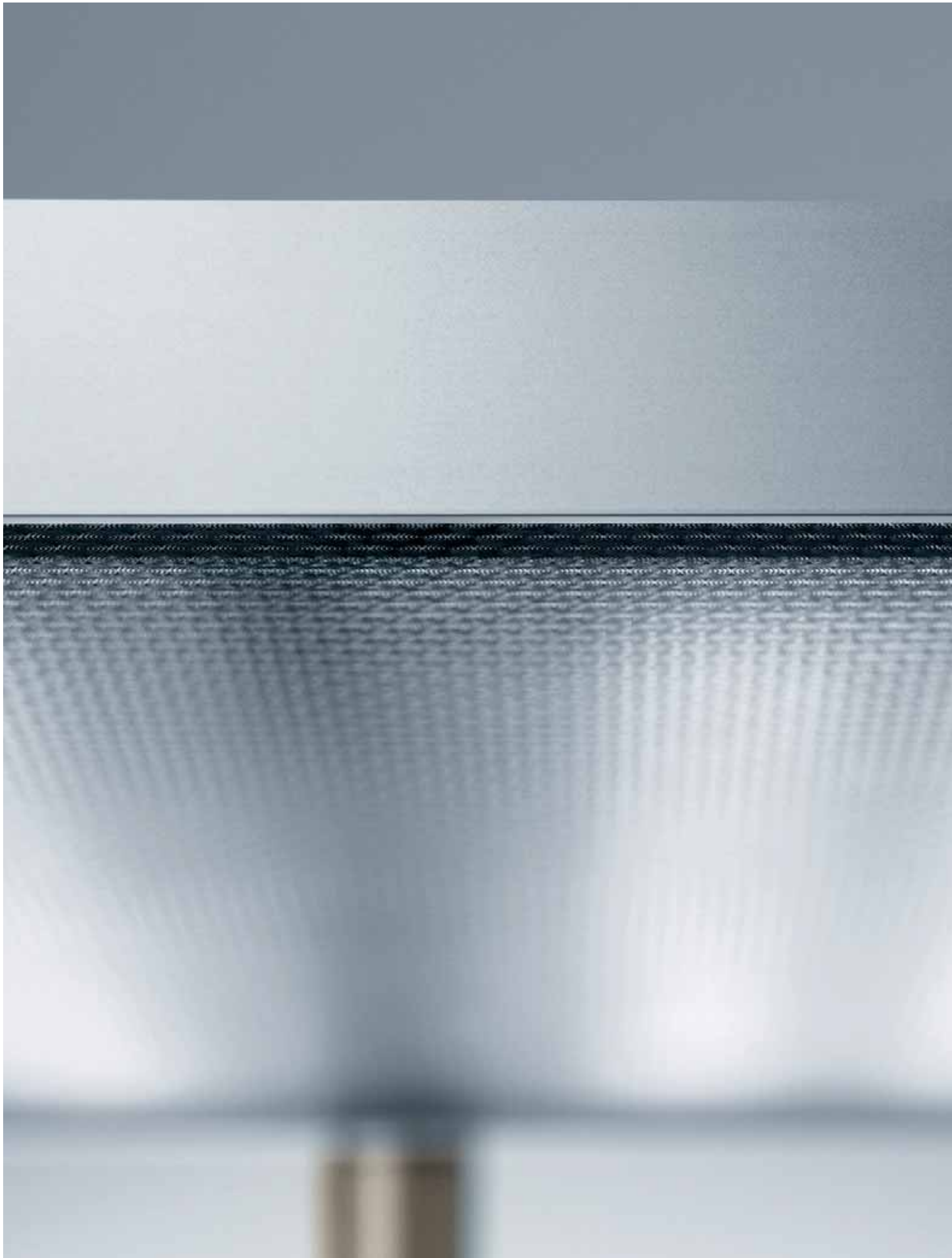







IF NOTHING IS LEFT TO REDUCE  
IN TERMS OF FORM, ONLY A  
SOPHISTICATED DESIGN REMAINS.



Good design means less is better. Every formal detail on the ATARO has a function.

The cuboid forms of ATARO reflect current architectural and design trends. Nonetheless, the ATARO design rises above any zeitgeist – a trait that distinguishes modern classics.

The curved edges of the lamp head are continued on the flat base and form a visually pleasant contrast with the straight-lined character of the luminaire.

The classy overall appearance is aesthetically perfected by the innovative Waldmann AMBIO glare-free technology. The coloration of the prism disk, measuring only 3mm, blends in well with the metallic surfaces of the ATARO.

# GOOD DESIGN TRANSCENDS ALL TRENDS. IT BECOMES PART OF THE SURROUNDINGS.

The ATARO design has been reduced to the basics and stands out with its clear design. As a result, ATARO meets a particularly important requirement of modern lighting solutions in office buildings: The luminaires can be integrated seamlessly in any architecture because they blend with every style.

The aluminum luminaire head, the high-quality coated support column, and the base additionally promote the perception of it being an integral part of the work environment.

ATARO is therefore often perceived, at first glance, in the form of pure function – as a pleasant, glare-free light that is evenly distributed in the entire room and creates a relaxed atmosphere.

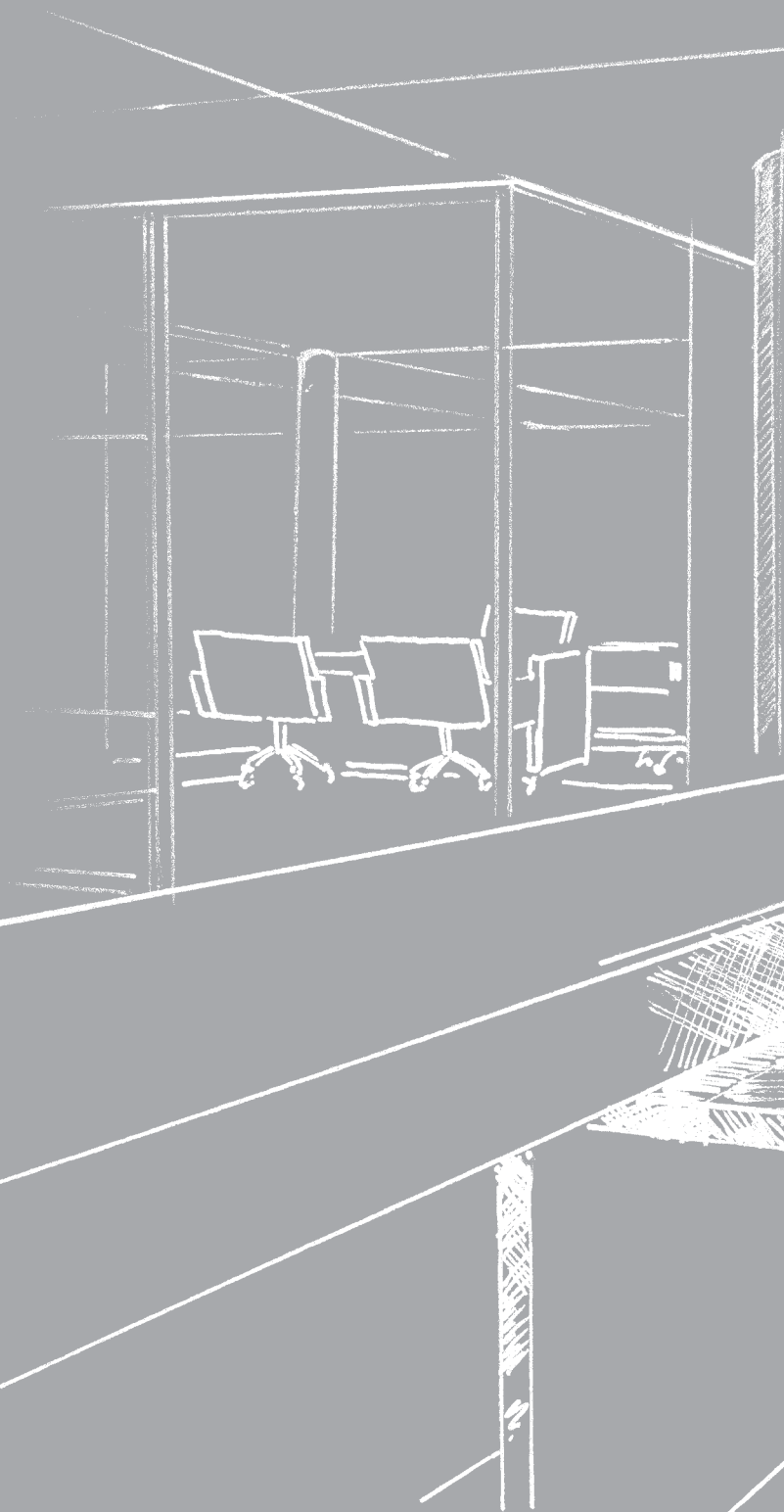









## **ATARO** STANDS OUT WITH **VISUAL CLARITY.**

The outstanding design of ATARO goes hand in hand with the maximum processing quality.

The luminaire head has an enclosed aluminum frame with elongated rounded areas. For personal adjustment of the lighting direction, the luminaire head can be turned 45° in either direction.

The material transitions are especially inconspicuous. The seams between the luminaire head, joint and support column are nearly indiscernible. The appearance is absolutely homogeneous – a seamless lighting design.

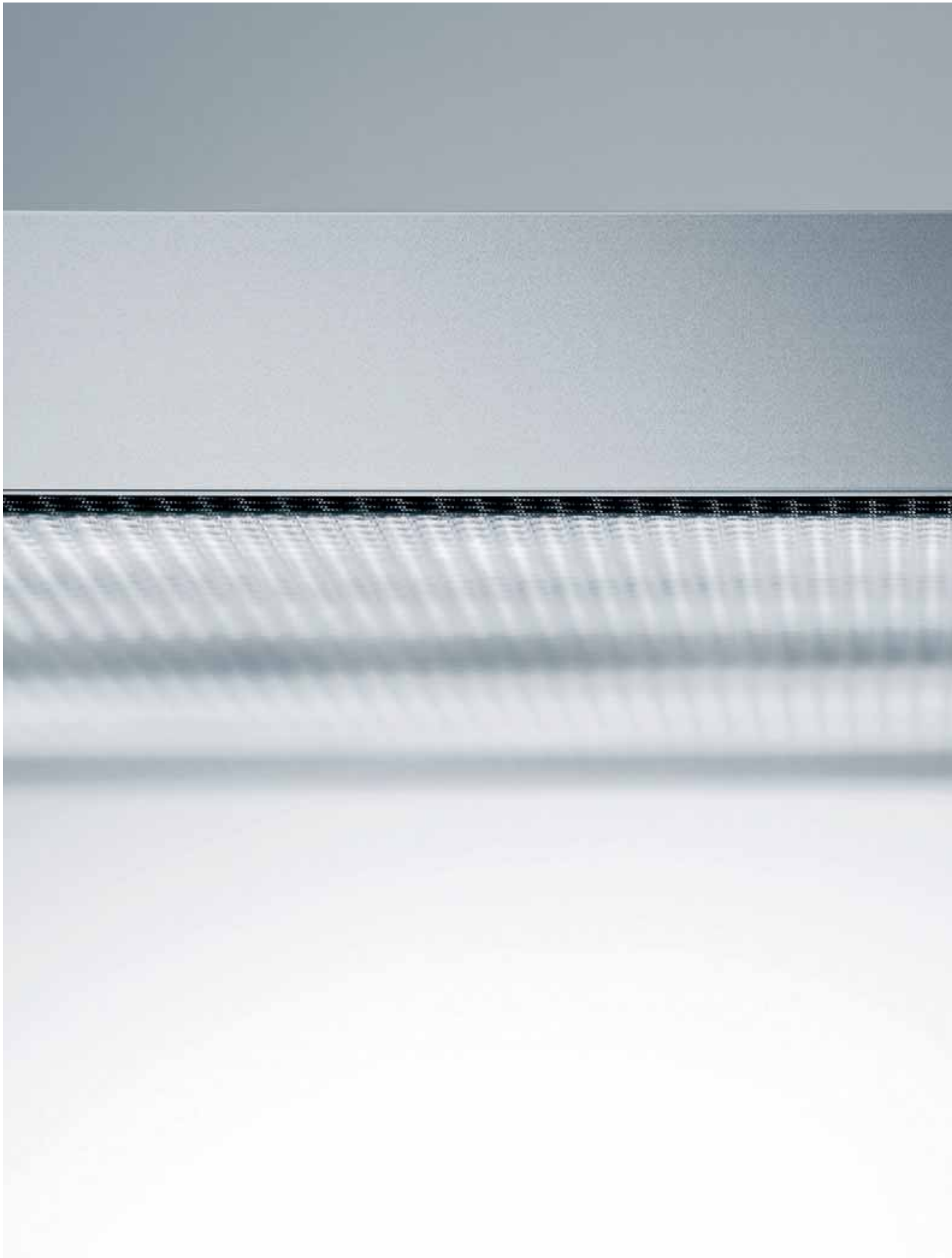





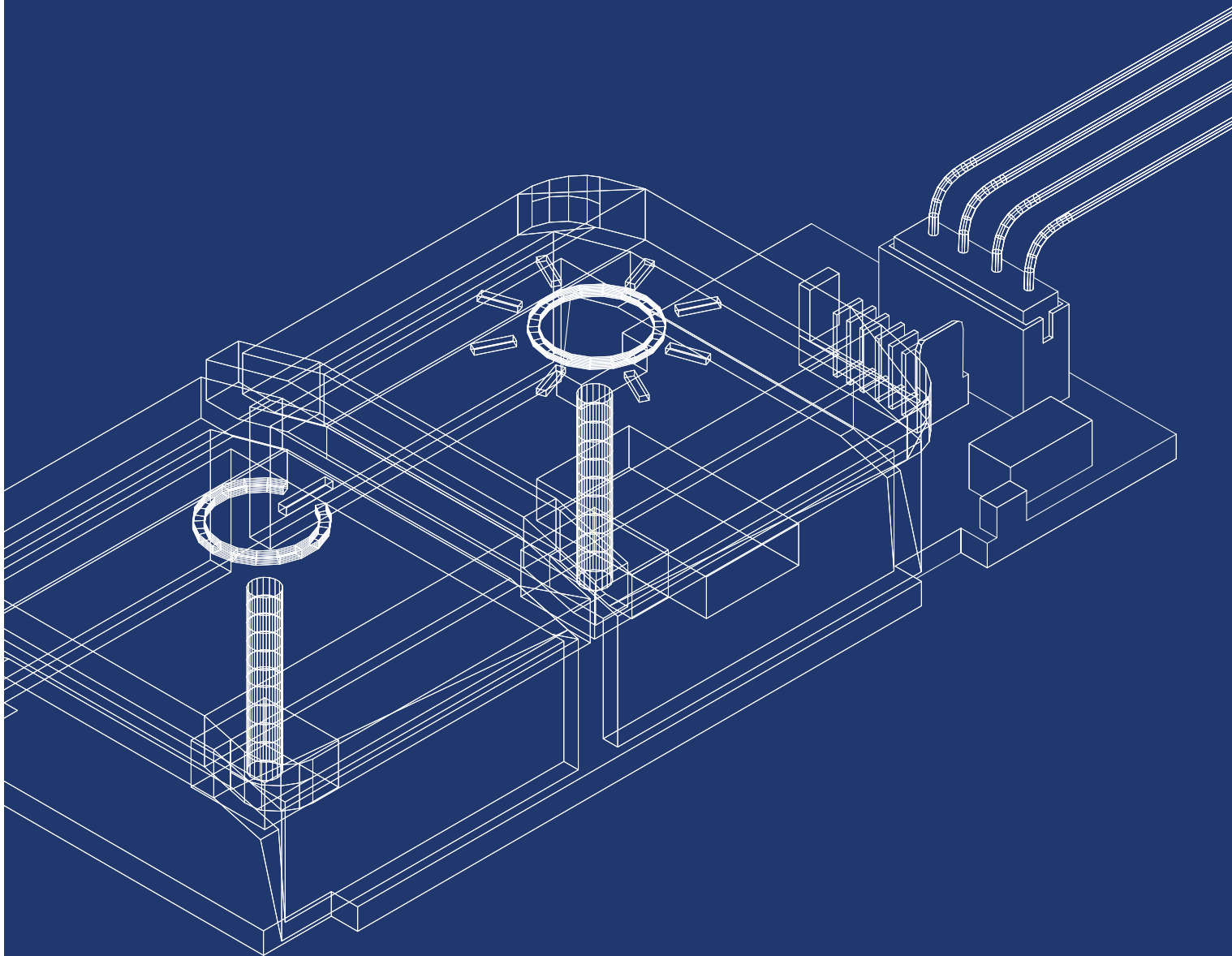

ATARO, WITH ITS STATE-OF-THE-ART **TECHNOLOGY**  
IS SELF-EXPLANATORY.





Clear association of the functionalities.

Intelligent electronics behind the cover.

Ideal positioning, therefore easy access.

Following the design of clear lines, the ATARO control element is integrated in the support column at working height. As a result, the free-standing luminaire can be comfortably reached while seated or standing.

The two touch fields, which are clearly marked with understandable icons, cover the most essential functions: switching on, switching off, and continuously variable adjustment of the light intensity.

The ergonomic, self-explanatory control element is a masterpiece of engineering skill. The intelligent electronics in sensor-controlled luminaires allow the programming of additional functions, such as the lag time or presence range, as well as the communication with "connected sockets" in all technical versions. ATARO can also be activated by external light switches, which are placed at the entrance of a room, for example.





## **ATARO** AUTOMATICALLY LOWERS ENERGY COSTS, THROUGH DAYLIGHT- AND PRESENCE-DETECTING SENSORS.

Approximately 30 % of the total energy consumption of an administrative building is due to lighting. Energy efficient luminaires therefore are gaining more and more importance.

ATARO is equipped with the unique Waldmann PULSE HFMD (High Frequency Motion Detector) sensor system.

PULSE HFMD captures even the slightest movements within a definable area by high frequency technology. ATARO accordingly switches on when someone enters the room, and automatically switches off again when the person leaves the room. In addition, the sensor technology regulates the light output of ATARO according to the daylight level. As a result, the power consumption of individual luminaires can be reduced by up to 50 % of its capacity.

In combination with the KNX/EIB, or LON components, ATARO PULSE HFMD becomes part of a highly sophisticated building and exchanges information with other systems. Additional modules, or custom-made products, are not required.

ATARO is also available as an option with the passive infrared sensor system, PULSE PIR.

KNX = Open Standard for home and building control

LON = Local Operating Network

Waldmann is a member of the DALI work group



For additional information regarding light management and building management systems, visit [www.waldmann.com](http://www.waldmann.com) "Architectural Lighting/Topics".

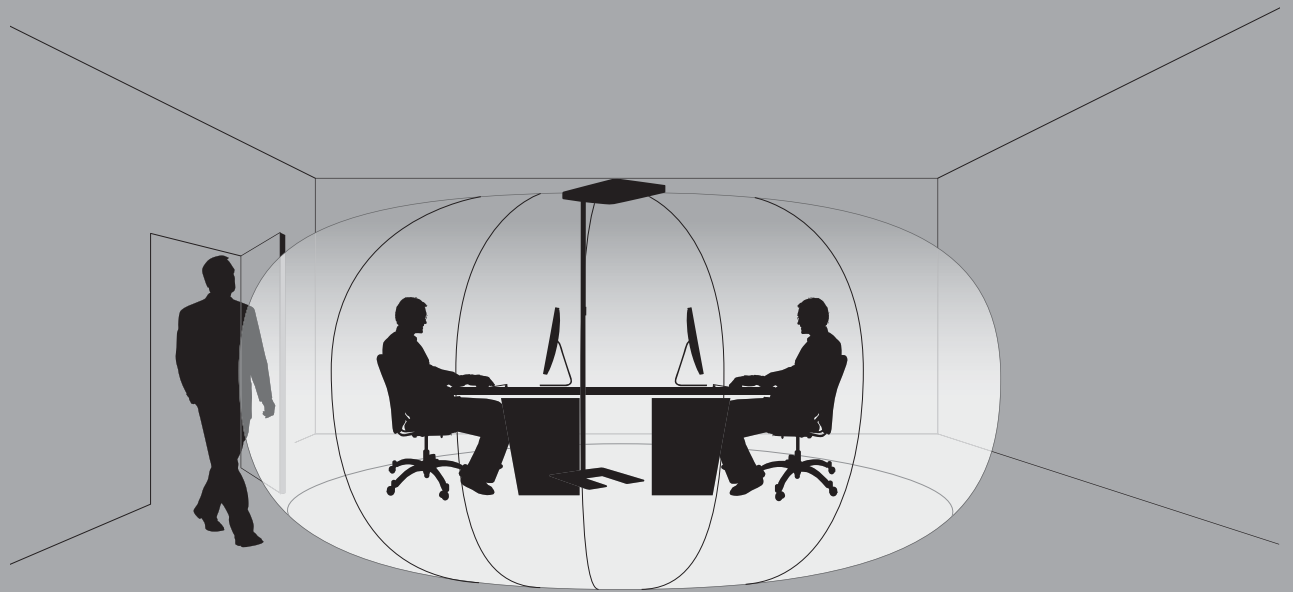

PULSE HFMD



PULSE PIR

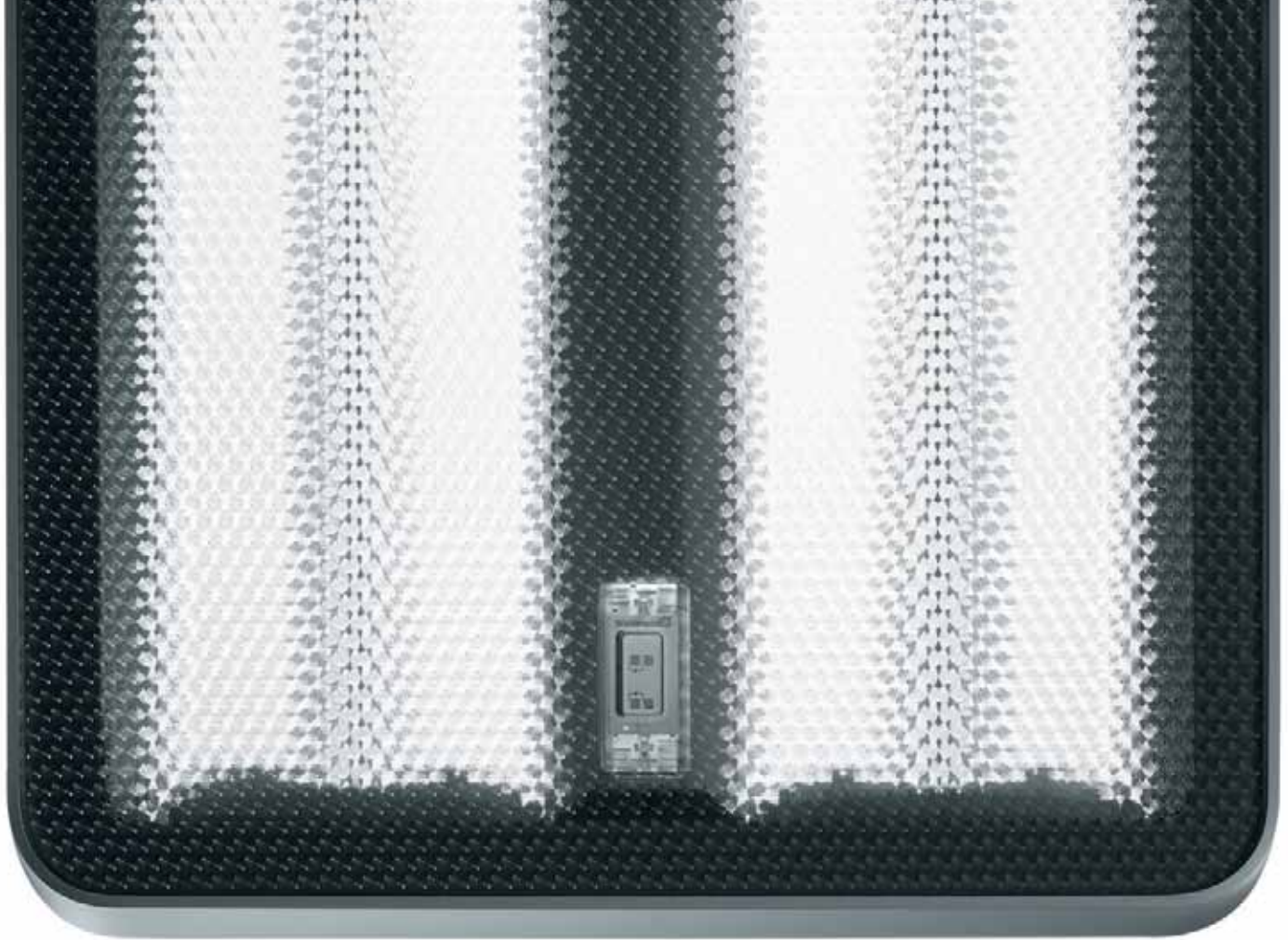

## KEEPING OUR FINGER ON THE PULSE: THE WALDMANN **LIGHT MANAGEMENT SYSTEMS.**

The intelligent PULSE light management system creates the best conditions for fulfilling the European energy efficiency guideline and the even stricter Swiss Minergie® requirements. PULSE combines presence and daylight sensor technology.

ATARO only switches on if the sensor detects the presence of people in the room and daylight is no longer sufficient. The on and off processes are barely noticed by the users because the light is slowly increased and dimmed. The state-of-the-art light management system not only saves a lot of power, but due to the low operating times the service life of the fluorescent lamps is also increased and the maintenance intervals become longer.





## ORDINARY LUMINAIRES SAVE POWER. BUT EXCELLENT ONES ALSO **SAVE TIME.**

Time is money. Maintenance requirements are a cost factor not to be neglected. After all, wherever people are employed, work hours make a noticeable difference in cost.

ATARO and its chassis concept make equipment management easier than ever before. To allow convenient cleaning, the frame and prism disk can be removed in just a few steps, without tools. Defective lamps are replaced with new ones just as quickly. All elements are conveniently accessible from beneath. As a result, the risky climbing onto desks or chairs is a thing of the past.

ATARO not only saves power, but also a lot of time.





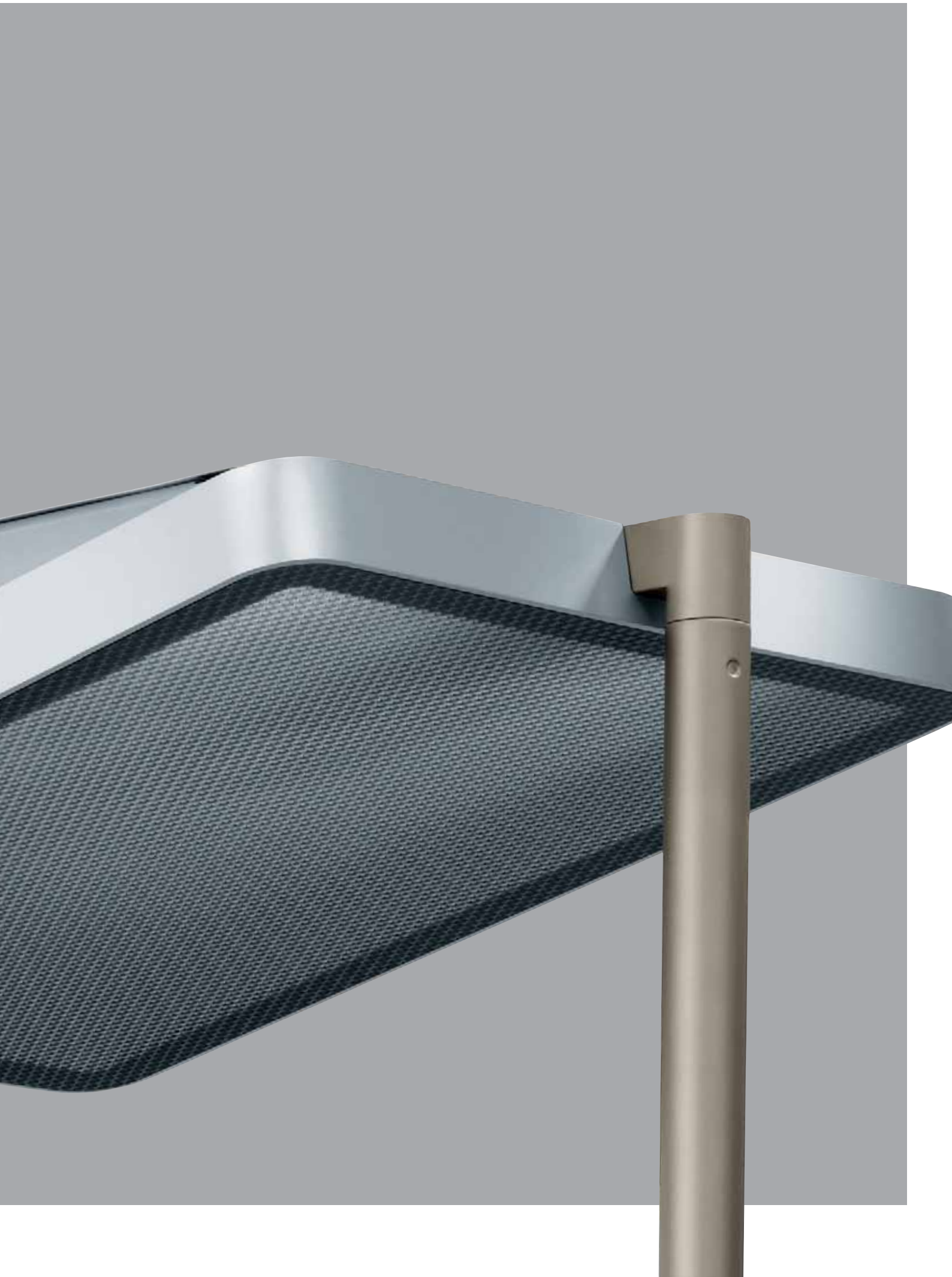

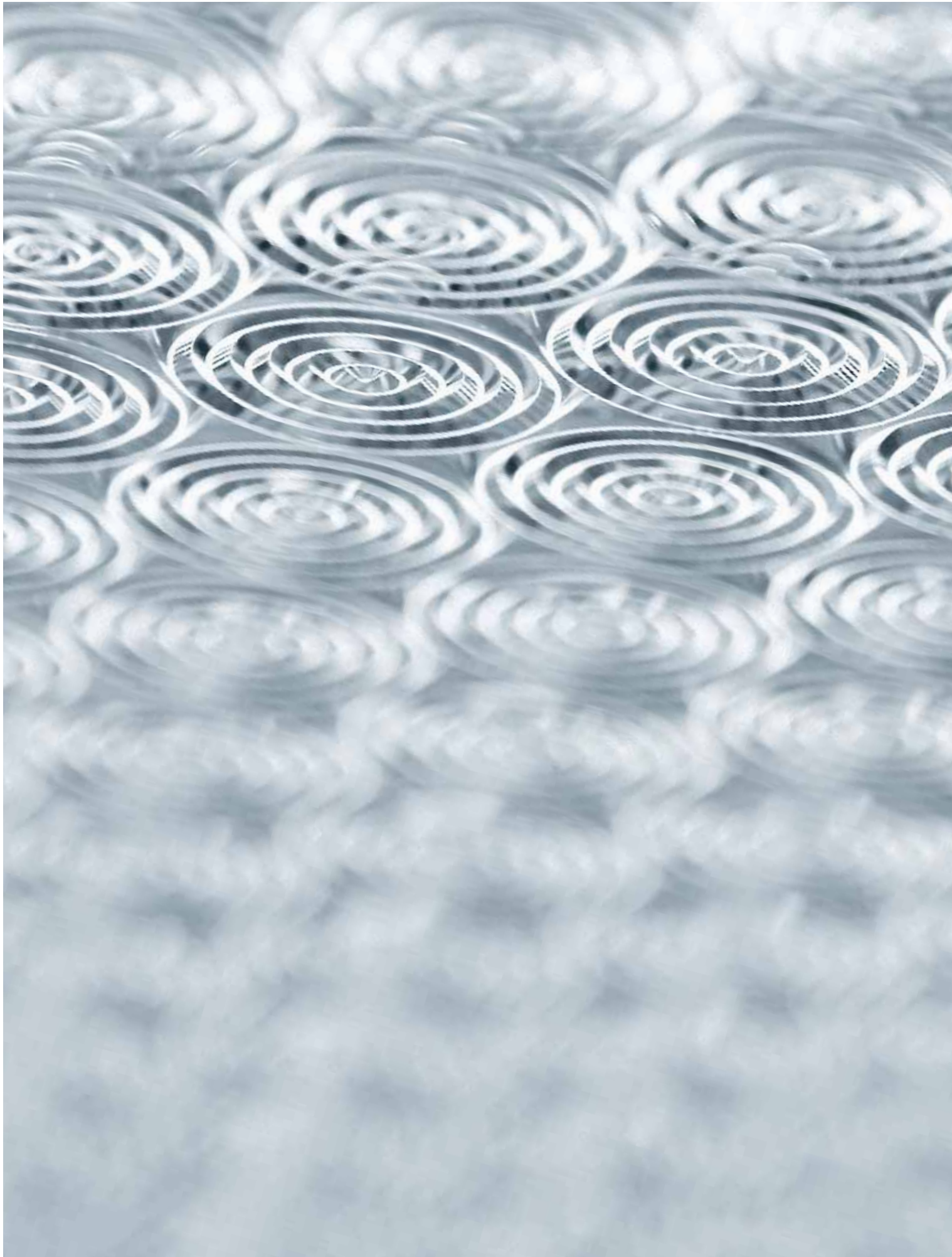



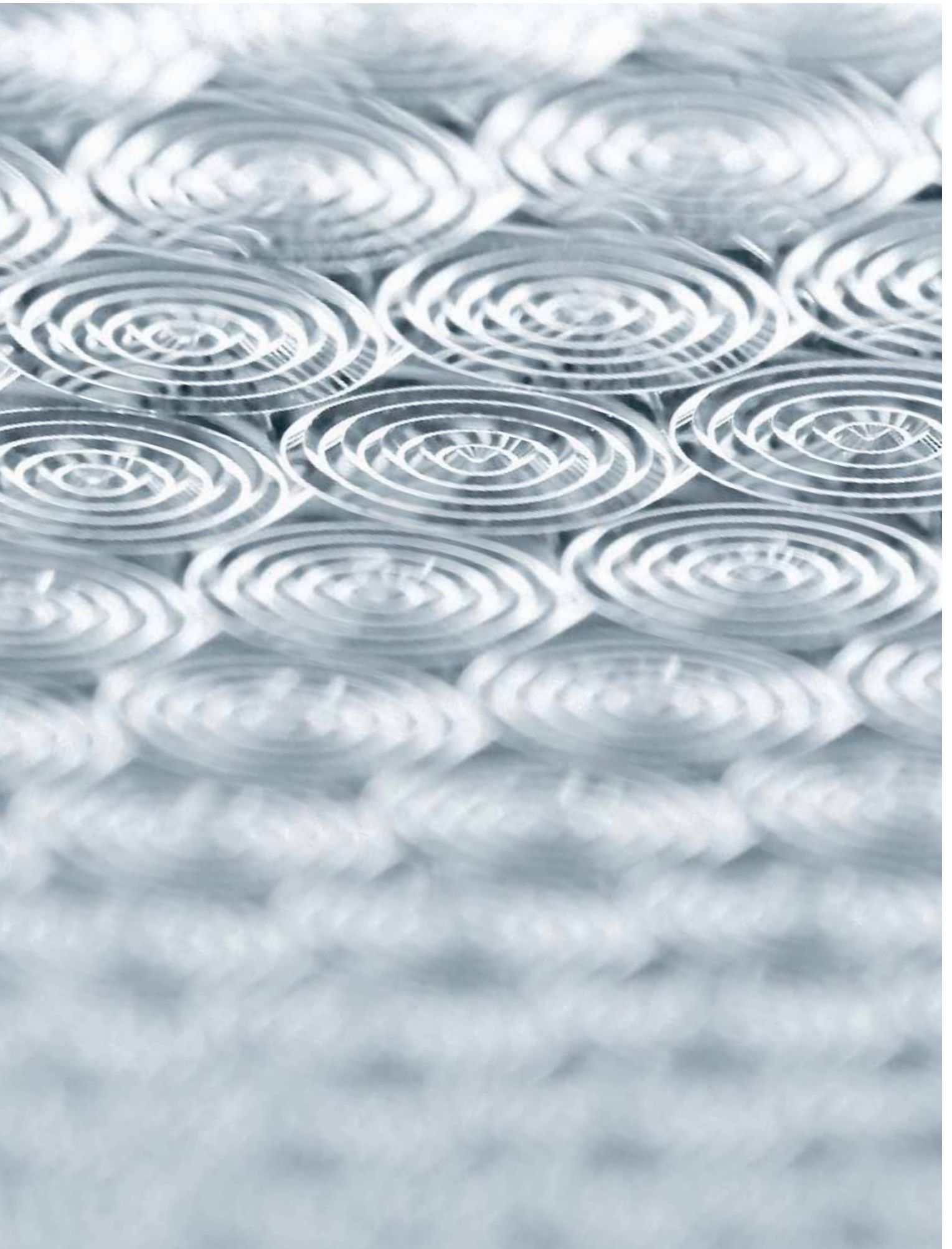



**AMBIO**

ATARO STANDS FOR THE HIGHEST  
**LIGHTING QUALITY** WITH 30 % LOWER  
ENERGY CONSUMPTION.



ATARO is equipped with a new exclusive feature: AMBIO, the innovative Waldmann glare-free technology. The core piece of AMBIO is a prism disk, whose surface consists of numerous microprisms. As a result, ATARO achieves complete all-round glare control according to EN 12464-1 and sets new standards where lighting quality is concerned.

The direct lighting portion of about 30 % ensures a high brightness level on the desk surface – without direct glare and without reflections on monitor surfaces and work tools. The majority of the light is emitted toward the ceiling and reflected from there homogeneously and pleasantly throughout the entire room.

Through the use of AMBIO, the power of installed lamps can be reduced from 55W to 40W. This corresponds to a 30 % reduction in power consumption. Additionally, due to AMBIO, efficiency increases to 74% – the new maximum level of free-standing luminaires.





AMBIO **GLARE SUPPRESSION**  
WITH ADDED VALUE.





AMBIO offers more lighting quality. AMBIO creates light without side effects. Direct glare or glare from reflections on monitor surfaces and other work tools are therefore effectively avoided. The prism disk provides optimum scattering of the light and distributes it evenly. The direct light portions are adjusted to the work place.



AMBIO offers more aesthetics. AMBIO is also a design highlight, because the prism disk, measuring only 3mm, allows more leeway for design. Visually, the coloration of the microprism blends with the metallic surfaces of the Waldmann ATARO indirect luminaire. The result is a uniform and all-round balanced appearance.



AMBIO offers even more light efficiency. Waldmann luminaires equipped with AMBIO can achieve extremely high efficiency, due to the optimized interaction between the lamp and optical and thermal aspects. This allows the best possible use of the light emitted by the lamp. AMBIO's light efficiency is hard to beat.

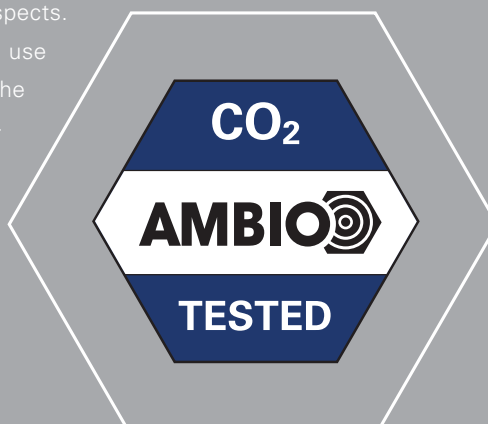

...the most economical illumination for the individual at the





## ATARO IS ANOTHER STRONG PILLAR OF THE WALDMANN **TWIN-C** PHILOSOPHY.

Optimum light at the workplace affects the body and the mind. It promotes productivity and health, creates safety, and saves energy. Optimum light requires TWIN-C from Waldmann, the intelligent lighting concept for integral lighting solutions using ideally combined lighting components. Free-standing luminaires, such as ATARO, are the support pillars in the architecture of a TWIN-C design. They adapt to every work situation, can be quickly installed on every work station, and thanks to the state of the art Waldmann technology, can be integrated in building management systems. Furthermore, in conjunction with AMBIO, ATARO also sets standards where lighting quality and light efficiency is concerned.

**ATARO** – SPECIAL FEATURES  
AT A GLANCE.

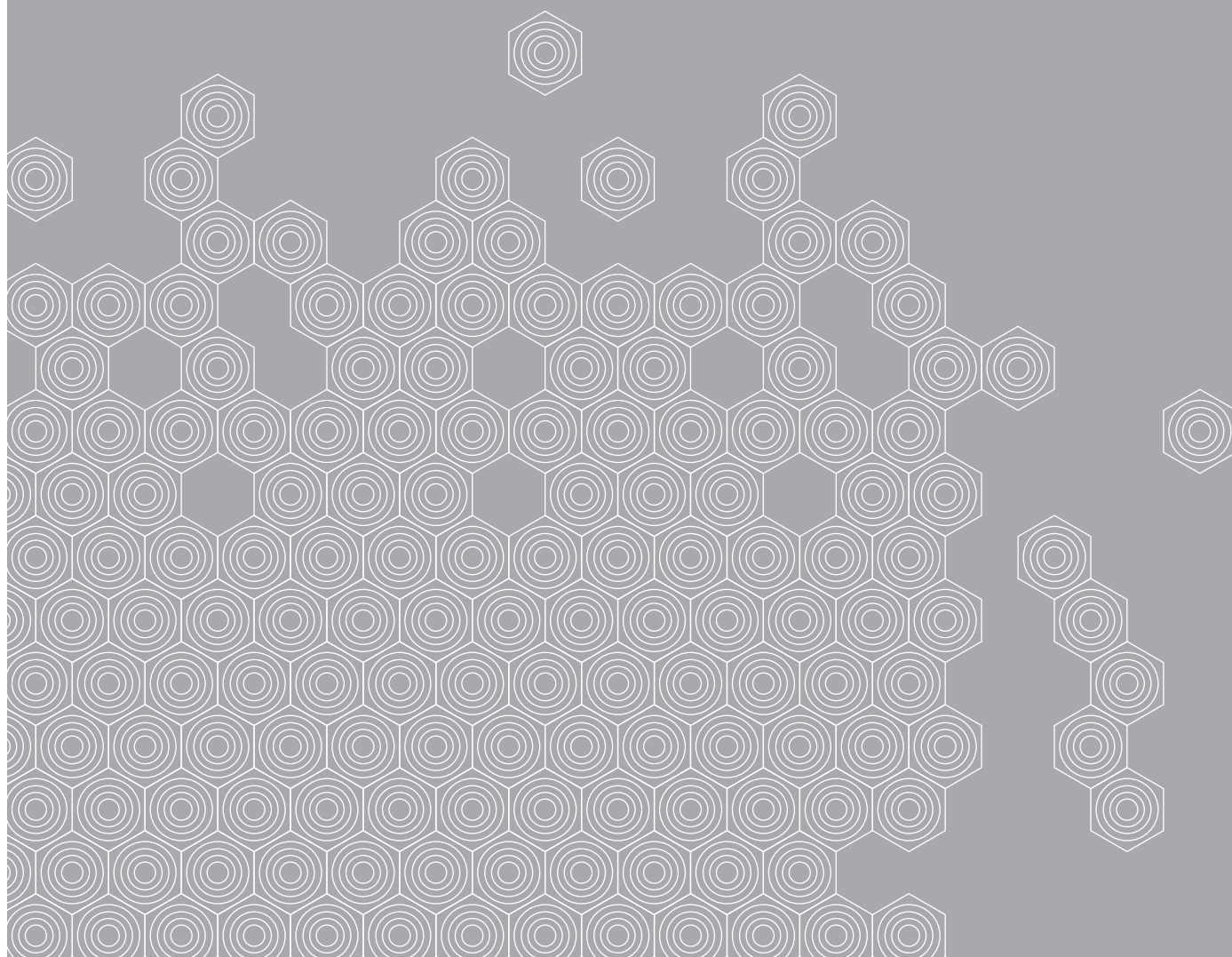

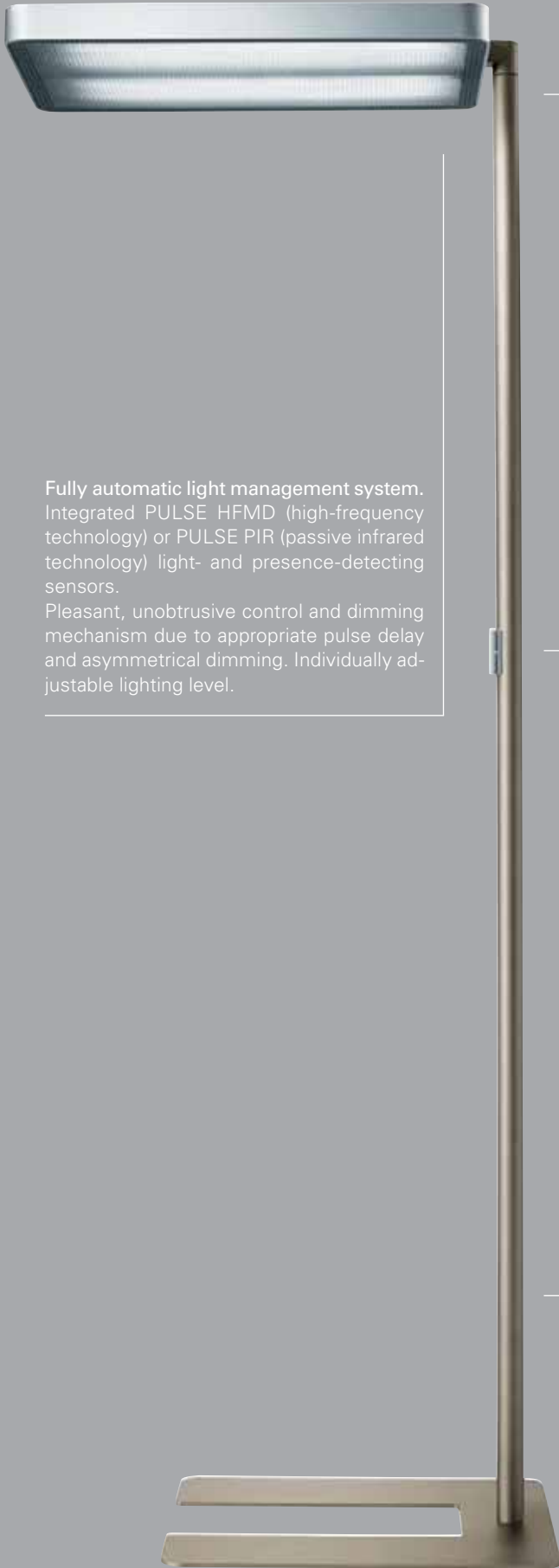

---

**Fully automatic light management system.** Integrated PULSE HFMD (high-frequency technology) or PULSE PIR (passive infrared technology) light- and presence-detecting sensors. Pleasant, unobtrusive control and dimming mechanism due to appropriate pulse delay and asymmetrical dimming. Individually adjustable lighting level.

---

---

**Lamp head, lighting quality, energy efficiency.** Lamp head can be rotated in both directions by 45°. All-round glare control, high lighting quality, and approximately 74 % efficiency. Thanks to AMBIO, 30 % lower energy requirement compared to conventional solutions (40 W instead of 55 W). Removable prism disk for easy replacement of lamps and simple cleaning.

---

---

**Convenient operation.** Multifunctional touch control element that can be comfortably reached while seated or standing. Connection to switched power outlets possible.

---

---

**Design.** Timeless discerning style. Enclosed aluminum frame and design appropriate for materials used. Forked, flat base for direct placement at the workplace.

---



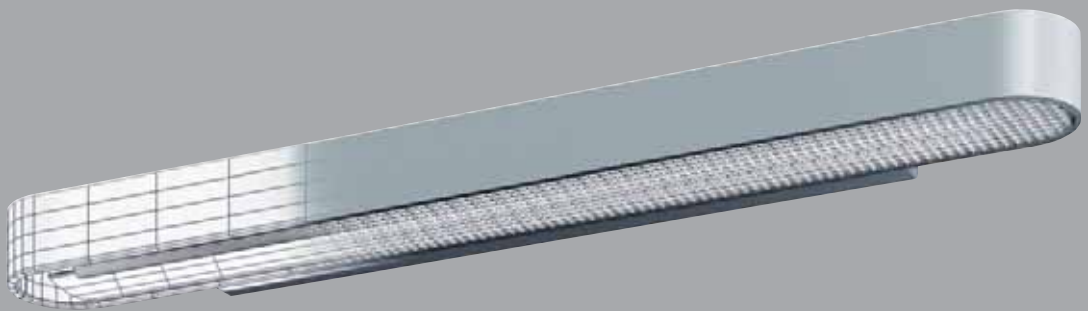
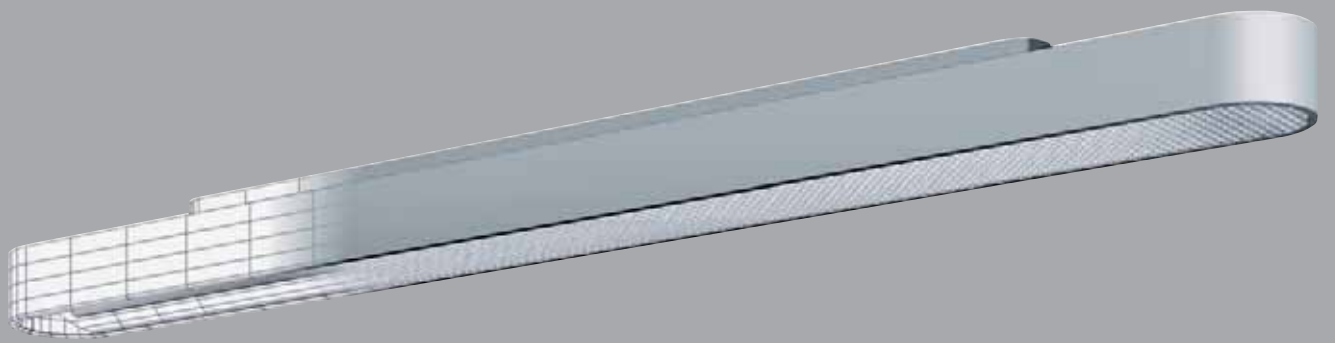
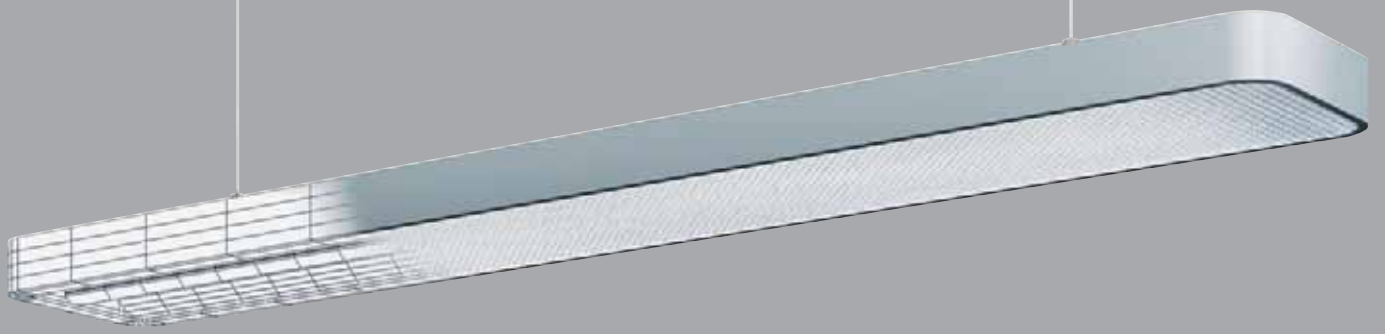



## THE **ATARO** LUMINAIRE FAMILY.

ATARO will be the future embodiment of a complete new luminaire family. Along with several freestanding models, pendant lights, ceiling and wall mounted lights will complete the ATARO family.

Within this concept, ATARO will fulfill even the most individual illumination requirements within a TWIN-C conception.

# TECHNICAL DATA

## ATARO FREE-STANDING AND TABLE-MOUNTED LUMINAIRE 4-TUBE

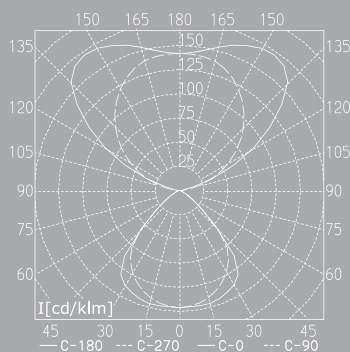

Free-standing/table-mounted luminaires

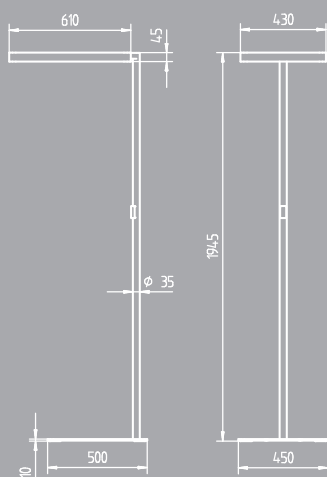

Free-standing luminaires

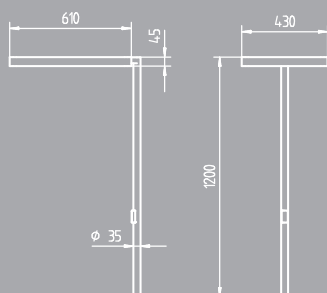

Table-mounted luminaires

POWER SUPPLY	230–240V; 50/60Hz
FITTED WITH	4 x compact fluorescent lamps TC-L 40W
WORK EQUIPMENT	Electronic ballast
POWER CONSUMPTION	approx. 165W
MAINS CONNECTION	approx. 3m; shock-proof plug
HOUSING MATERIAL	Anodized aluminum
LOWER ARM	Painted Steeltube
FOOT	Steel plate rectangular, flat, painted
OPERATION	Multi-function switch in tubular section
OPERATING EFFICIENCY	74 %
LIGHT DISTRIBUTION	Symmetrical; direct light portion approx. 30 %
DIFFUSION	Light-amplifying AMBIO microprism, average luminance on reflector according to EN 12464-1 requirements
LAMP COVER	None

### SPECIAL FEATURES

- Integrated PULSE HFMD (high-frequency technology) or PULSE PIR (passive infrared technology) light- and presence-detecting sensors
- Sensitive response; pleasant, inconspicuous control and dimming behaviour thanks to appropriate impulse delay and asymmetrical dimming
- Individually adjustable lighting level
- Easy-to-reach multifunctional operating element. (Can be connected to switched power sockets.)
- Luminaire head can be pivoted by +/- 45°
- Removable prism disk for easy replacement of lamps and simple cleaning

FREE-STANDING LUMINAIRES	TYPE	EQUIPPED WITH	ORDER NO. WHITE	ORDER NO. CHAMPAGNE
Free-standing luminaire switchable	DUS 440	4 x 40W	121 220 001	121 220 000
Free-standing luminaire dimmable	DUS 440/D	4 x 40W	121 221 001	121 221 000
DALI free-standing luminaire dimmable	DUS 440/D	4 x 40W	121 227 001	121 227 000
PULSE PIR free-standing luminaire	DUS 440/R	4 x 40W	121 223 001	121 223 000
PULSE HFMD free-standing luminaire	DUS 440/P	4 x 40W	121 222 001	121 222 000
PULSE EIB free-standing luminaire	DUS 440/PB	4 x 40W	121 224 001	121 224 000
PULSE LON free-standing luminaire	DUS 440/PB	4 x 40W	121 225 001	121 225 000

TABLE-MOUNTED LUMINAIRES	TYPE	EQUIPPED WITH	ORDER NO. WHITE	ORDER NO. CHAMPAGNE
Table-mounted luminaire switchable	DUT 440	4 x 40W	121 541 001	121 541 000
Table-mounted luminaire dimmable	DUT 440/D	4 x 40W	121 542 001	121 542 000
PULSE PIR table-mounted luminaire	DUT 440/R	4 x 40W	121 543 001	121 543 000
PULSE HFMD table-mounted luminaire	DUT 440/P	4 x 40W	121 544 001	121 544 000

ACCESSORIES	ITEM	ORDER NO.
PULSE EIB/LON free-standing luminaire	Data line	210 218 019
	Power line shock-proof connector	330 293 020
Table-mounted luminaires	Mains cable shock-proof plug	
	Span 20-28mm	191 102 059
	(Other adaptations available on request)	