

---

**INDUSTRIAL LIGHTING SOLUTIONS**  
PRODUCT CATALOG

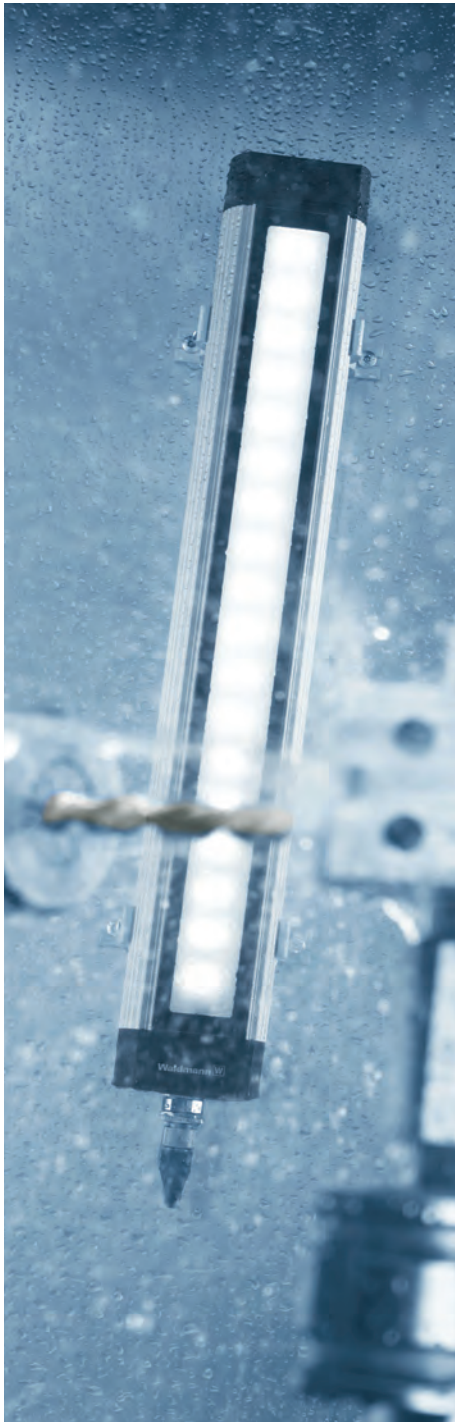

# THE RIGHT LIGHT FOR EVERY APPLICATION



## MACHINING

The machining industry requires its own set of specific criteria for lighting machining environments. Bright lighting inside the machine cabinet, without shadows or glare, is a must. It must be reliable, easy to clean and maintain, and rugged enough to withstand flying metal chips, lubricants and oils found in the machining process. Waldmann offers the very best quality and widest selection of LED machine luminaires available on the market today.



## ASSEMBLY

Proper lighting is crucial for an assembly environment to ensure that quality products are manufactured and assembled correctly the first time. High-performance lighting positively affects employees by boosting productivity, morale and well-being while minimizing eye strain and fatigue. Providing sufficient light without shadows or glare is necessary for keeping staff alert and safe.



## QUALITY CONTROL

Quality Control is the last point of inspection before a product reaches the customer. Proper lighting and magnification equipment is imperative to ensure that any defects or imperfections are identified prior to shipment. Waldmann magnifiers offer wide angle distortion-free lenses with additional lenses available for added power. High color rendering and dimming options allow for customization of the task.



## MAINTENANCE

In the industrial environment, maintenance departments keep production machines operational. Energy savings and cost-efficiency affect the bottom line 24/7. Waldmann ensures maintenance-free lighting by using the highest quality lighting components available, combined with superior design and the latest technological advances. There is no down time, no replacement parts and no extra maintenance required to keep the lights on.



## RESEARCH AND DEVELOPMENT

Research and Development is an important component of any growing business. Waldmann develops products that easily integrate into R&D workstations that require high illuminance levels while eliminating shadows or glare. Task and bench lighting products allow for precise movement and positioning of the fixture for optimum comfort and control while utilizing premium materials and components.

# INDUSTRIAL LIGHTING SOLUTIONS

MACHINE . . . . . 4-37

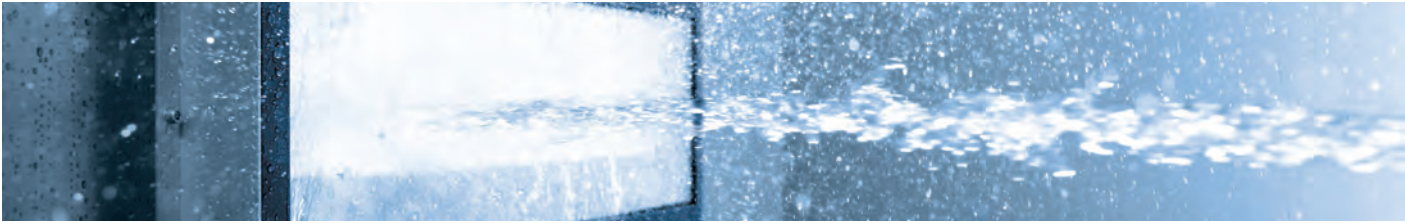

TASK & WORKBENCH . . . . . 38-49



MAGNIFICATION & INSPECTION . . . . . 50-59

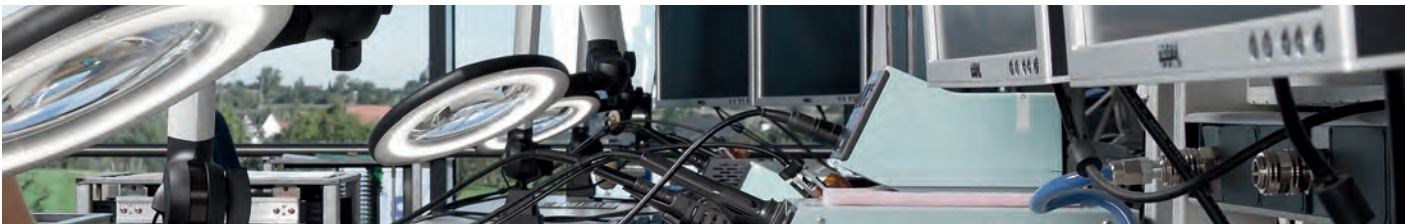

FACILITY . . . . . 60-65



ACCESSORIES . . . . . 66-77



PART NUMBER INDEX . . . . . 78-81

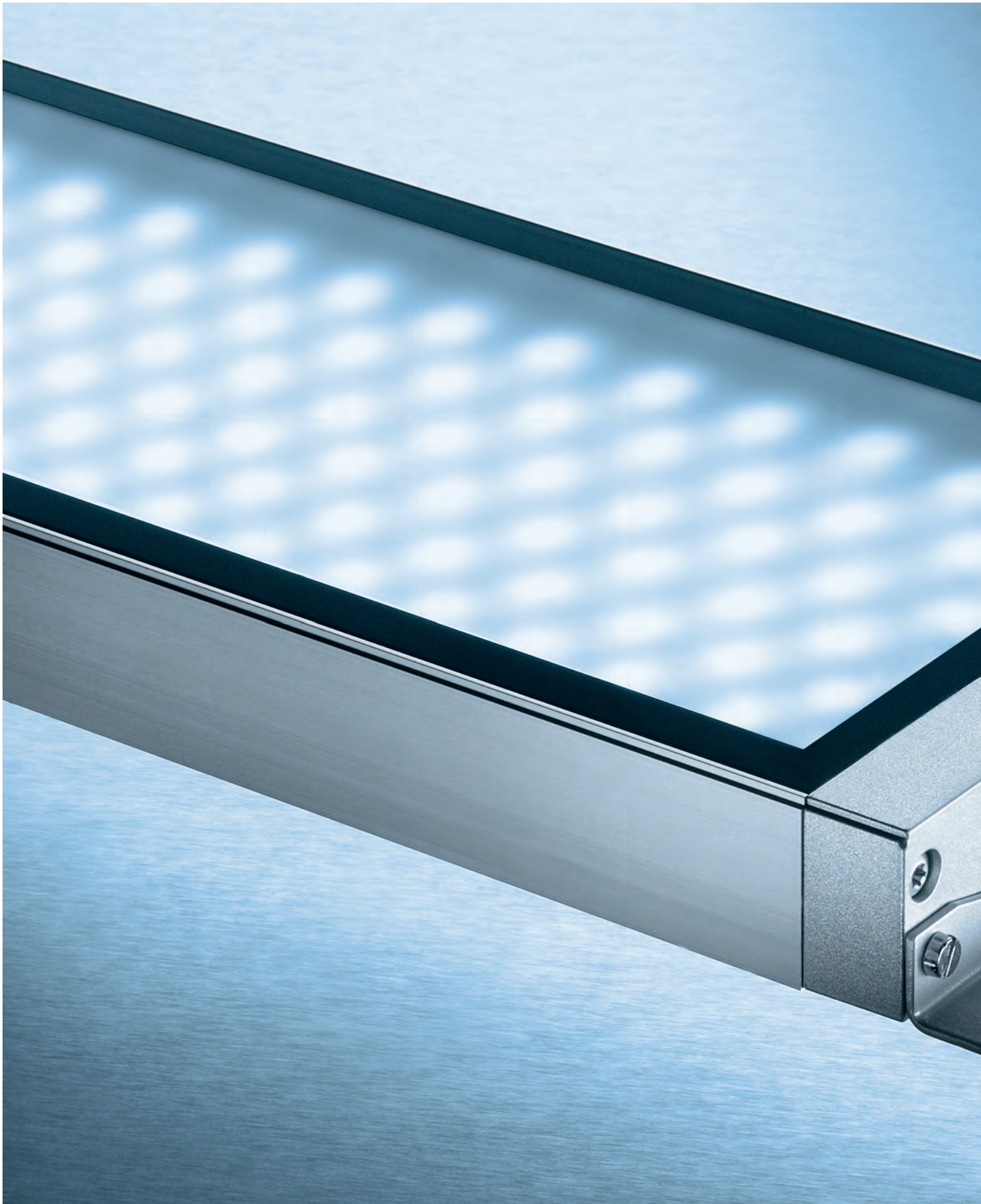

## INDUSTRIAL LIGHTING | MACHINE

<b>MACH LED PLUS.seventy</b> - 70 mm LINEAR LED MACHINE LIGHT	<b>6 - 7</b>
<b>MACH LED PLUS.forty</b> - 40 mm LINEAR LED MACHINE LIGHT	<b>8 - 9</b>
<b>LUMATRIS</b> - HIGH OUTPUT LED MACHINE LIGHT	<b>10 - 11</b>
<b>MACH LED PRO</b> - HIGH OUTPUT MACHINE LIGHT	<b>12 - 13</b>
<b>FLAT LED</b> - HIGH OUTPUT LED LIGHT	<b>14 - 15</b>
<b>ROCIA.focus</b> - HIGH OUTPUT LED SPOT LIGHT	<b>16 - 17</b>
<b>ROCIA.planar</b> - HIGH OUTPUT LED TASK LIGHT	<b>18 - 19</b>
<b>RAPTOR</b> - INDUSTRIAL LED SPOT LIGHT	<b>20 - 21</b>
<b>ABL LED</b> - COMPACT LED SPOT LIGHT	<b>22 - 23</b>
<b>HEAD LED</b> - SURFACE MOUNT LED FLOOD LIGHT	<b>24 - 25</b>
<b>ONE LED</b> - COMPACT LED FLOOD LIGHT	<b>26 - 27</b>
<b>SLIM LED</b> - COMPACT LINEAR LED LIGHT	<b>28 - 29</b>
<b>RL70LE</b> - INDUSTRIAL LED TUBE LIGHT	<b>30 - 31</b>
<b>RL70</b> - LINEAR FLUORESCENT TUBE LIGHT	<b>32 - 35</b>
<b>AWD</b> - COMPACT WATERPROOF TUBE LIGHT	<b>36 - 37</b>

Machine

Task &amp; Workbench

Magnification &amp; Inspection

Facility Lighting

Accessories



MACH LED PLUS linear LED machine lights are available in various lengths

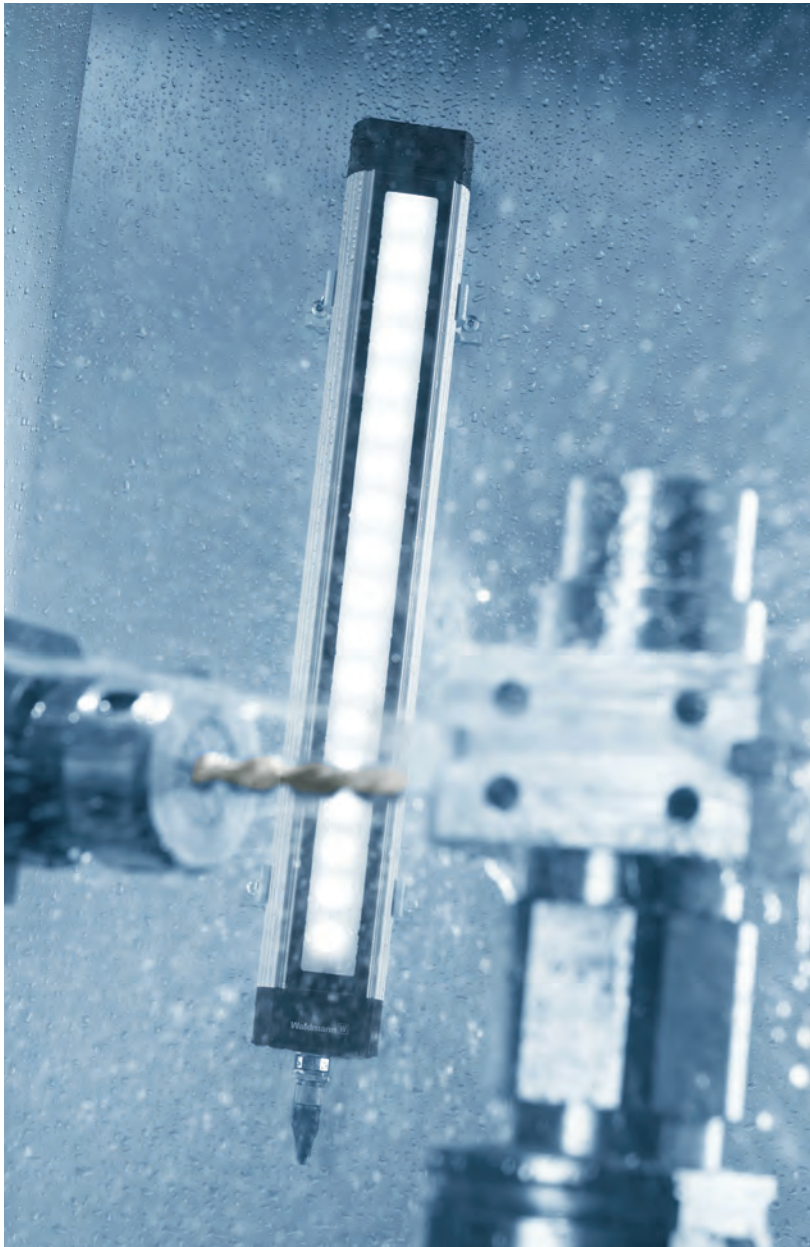

# MACH LED PLUS. seventy

## 70 MM LINEAR LED MACHINE LIGHT

### FEATURES:

- Compatible with standard 70 mm tube lights for easy retrofit of existing fluorescent tubes to LED
- Up to 70% energy savings compared to fluorescent lamp fixtures
- Six lengths to fit any machine configuration
- Two lumen packages available, Eco or High-output
- 60,000 hours of maintenance-free operation with high-performance, high-output LED technology
- Anodized aluminum housing and 4 mm thick safety glass ensures trouble-free operation in harsh environments
- Easy connection via M12 connector w/ cable assembly (included)
- Available in both line voltage and low voltage
- Designed for use with coolants and lubricants

### SPECIFICATIONS:

Voltage	18-30 VDC or 100-240 VAC; 50/60 Hz
Lamping	LED
Color Temperature	5000 K
Color Rendering Index (CRI)	85
Beam Angle	80°
Luminaire Material	anodized aluminum
Lens Material	borosilicate safety glass
Dimension	6 lengths, 2.75" (70 mm) diameter
Max Temperature Ratings	
<i>Eco</i>	122°F (50°C) 18-30 VDC or 113°F (45°C) 100-277 VAC
<i>Power</i>	113°F (45°C) 18-30 VDC or 104°F (40°C) 100-277 VAC
Connection	M12 connector w/ 16' cable assembly included
Protection Rating	IP67
Certification	ETL/cETL, CE
Mounting and accessories	See page 70

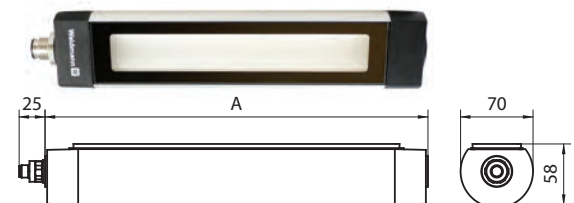

See chart for individual lengths (A)  
Measurements in millimeters

MACH LED PLUS.seventy is the ideal LED solution for linear machine lighting applications. It produces intense illumination for the most demanding industrial applications. It is impervious to mechanical vibration and resistant to coolants and lubricants. Designed for high temperature environments, MACH LED PLUS.seventy is a direct replacement for standard 70 mm tube lights used in many machines and allows use of existing mounting brackets. Thanks to a well-engineered design, superior craftsmanship and highest quality materials, MACH LED PLUS.seventy withstands the toughest conditions found in manufacturing and machining environments.

## ORDERING INFORMATION

Version	Wattage	Length (A)	Lumens	Model	Part #
<b>18-30 VDC Versions</b> (For AC voltage operation, see external operating devices below)					
Eco	5 W	14.6" (370 mm)	500	MQAL 12 S	113045000-00580702
Eco, thru-wire	5 W	14.6" (370 mm)	500	MQAL 12 SD	113046000-00580696
High-output	12 W	14.6" (370 mm)	1100	MQAL 24 S	113047000-00580693
High-output, thru-wire	12 W	14.6" (370 mm)	1100	MQAL 24 SD	113048000-00580573
Eco	7.5 W	20.1" (510 mm)	750	MQAL 18 S	113053000-00580588
Eco, thru-wire	7.5 W	20.1" (510 mm)	750	MQAL 18 SD	113054000-00580591
High-output	18 W	20.1" (510 mm)	1650	MQAL 36 S	113055000-00580594
High-output, thru-wire	18 W	20.1" (510 mm)	1650	MQAL 36 SD	113056000-00580597
Eco	7.5 W	22.2" (565 mm)	750	MQAL 18 S	113061000-00580612
Eco, thru-wire	7.5 W	22.2" (565 mm)	750	MQAL 18 SD	113062000-00580615
High-output	18 W	22.2" (565 mm)	1650	MQAL 36 S	113063000-00580618
High-output, thru-wire	18 W	22.2" (565 mm)	1650	MQAL 36 SD	113064000-00580621
Eco	10 W	25.6" (650 mm)	1000	MQAL 24 S	113069000-00580639
Eco, thru-wire	10 W	25.6" (650 mm)	1000	MQAL 24 SD	113070000-00580642
High-output	24 W	25.6" (650 mm)	2200	MQAL 48 S	113071000-00580645
High-output, thru-wire	24 W	25.6" (650 mm)	2200	MQAL 48 SD	113072000-00580648
Eco	13 W	31.1" (790 mm)	1250	MQAL 30 S	113077000-00580663
Eco, thru-wire	13 W	31.1" (790 mm)	1250	MQAL 30 SD	113078000-00580666
High-output	30 W	31.1" (790 mm)	2700	MQAL 60 S	113124000-00611855
High-output, thru-wire	30 W	31.1" (790 mm)	2700	MQAL 60 SD	113125000-00612844
Eco	18 W	42.1" (1070 mm)	1750	MQAL 42 S	113081000-00580675
Eco, thru-wire	18 W	42.1" (1070 mm)	1750	MQAL 42 SD	113082000-00580681
High-output	42 W	42.1" (1070 mm)	3700	MQAL 84 S	113126000-00612973
High-output, thru-wire	42 W	42.1" (1070 mm)	3700	MQAL 84 SD	113122000-00609807
<b>100-240 VAC Versions</b>					
Eco	7 W	14.6" (370 mm)	500	MQAL 12 N	113049000-00580576
Eco, thru-wire	7 W	14.6" (370 mm)	500	MQAL 12 ND	113050000-00580579
High-output	15 W	14.6" (370 mm)	1100	MQAL 24 N	113051000-00580582
High-output, thru-wire	15 W	14.6" (370 mm)	1100	MQAL 24 ND	113052000-00580585
Eco	9.5 W	20.1" (510 mm)	750	MQAL 18 N	113057000-00580600
Eco, thru-wire	9.5 W	20.1" (510 mm)	750	MQAL 18 ND	113058000-00580603
High-output	21 W	20.1" (510 mm)	1650	MQAL 36 N	113059000-00580606
High-output, thru-wire	21 W	20.1" (510 mm)	1650	MQAL 36 ND	113060000-00580609
Eco	9.5 W	22.2" (565 mm)	750	MQAL 18 N	113065000-00580624
Eco, thru-wire	9.5 W	22.2" (565 mm)	750	MQAL 18 ND	113066000-00580630
High-output	21 W	22.2" (565 mm)	1650	MQAL 36 N	113067000-00580633
High-output, thru-wire	21 W	22.2" (565 mm)	1650	MQAL 36 ND	113068000-00580636
Eco	12 W	25.6" (650 mm)	1000	MQAL 24 N	113073000-00580651
Eco, thru-wire	12 W	25.6" (650 mm)	1000	MQAL 24 ND	113074000-00580654
High-output	27 W	25.6" (650 mm)	2200	MQAL 48 N	113075000-00580657
High-output, thru-wire	27 W	25.6" (650 mm)	2200	MQAL 48 ND	113076000-00580660
Eco	15 W	31.1" (790 mm)	1250	MQAL 30 N	113079000-00580669
Eco, thru-wire	15 W	31.1" (790 mm)	1250	MQAL 30 ND	113080000-00580672
Eco	20 W	42.1" (1070 mm)	1750	MQAL 42 N	113083000-00580684
Eco, thru-wire	26 W	42.1" (1070 mm)	1750	MQAL 42 ND	113084000-00580690
<b>External Operating Devices</b>					
	<b>Max. Wattage</b>	<b>Input</b>		<b>Output</b>	<b>Part #</b>
Required for 100-277 VAC operation with 18-30 VDC versions	20 W	100-277 VAC, 50/60 Hz		24 VDC	209585029
	50 W	120 VAC, 50/60 Hz		24 VDC	209585030
	96 W	120-277 VAC, 50/60 Hz		24 VDC	209585032
<b>Mounting Options</b>					
	<b>Item</b>			<b>Unit</b>	<b>Part #</b>
	End bracket set, adjustable, stainless steel +/- 65°			Sold as set	408001876-00582065
	Clip bracket, adjustable, aluminum +/- 30°			Sold individually	408001878-00585535
	Protective cap set (not for use with end brackets)			Sold as set	408001875-00582072
<b>Accessories</b>					
	<b>Item</b>	<b>Type</b>	<b>Voltage</b>	<b>Part #</b>	
	M12 connector w/ 16' cable assembly (included), straight	A-coded	18-30 VDC	US0009001	
	M12 connector w/ 16' cable assembly (included), straight	S-coded	100-240 VAC	US0009201	
	M12 connector w/ 16' cable assembly, angled	A-coded	18-30 VDC	US0009011	
	M12 connector w/ 16' cable assembly, angled	S-coded	100-240 VAC	US0009211	

Machine

Task &amp; Workbench

Magnification &amp; Inspection

Facility Lighting

Accessories



MACH LED PLUS linear LED machine lights are available in various lengths



# MACH LED PLUS. forty

## 40 MM LINEAR LED MACHINE LIGHT

### FEATURES:

- Four lengths: 7.5" (190 mm), 14.4" (365 mm), 21.3" (540 mm), 28.2" (715 mm)
- Beam angle options: 40° or 90°
- Rugged anodized aluminum housing and 4 mm thick safety glass
- Various bracket options for simple installation
- Able to withstand extreme ambient heat up to 122°F (50°C)
- 60,000 hours of maintenance-free operation
- Vibration resistant > 55 Hz (amplitude 0.35 mm); Shock resistant > .11 lb
- Protection rating IP67
- Easy connection via M12 connector w/ cable assembly (included)
- Designed for use with coolants and lubricants

### SPECIFICATIONS:

Voltage	20–28 VDC
Lamping	LED
Color Temperature	5000 K
Color Rendering Index (CRI)	85
Beam Angles	40° or 90°
Luminaire Material	anodized aluminum
Lens Material	borosilicate safety glass
Dimension	4 lengths, 1.6" (40 mm) diameter
Max Temperature Rating	122°F (50°C)
Connection	M12 connector w/ 16' cable assembly included
Protection Rating	IP67
Certification	ETL/cETL, CE
Mounting and accessories	See page 70

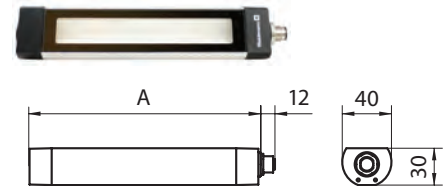

See chart for individual lengths (A)  
Measurements in millimeters

Waldmann has combined the positive attributes of MACH LED PLUS.seventy with the small form factor of the very popular MACH LED to develop MACH LED PLUS.forty – 1.6" in diameter with light output extending the full length of the fixture. It is available with a choice of beam angle, four different lengths, and 60,000 hours of maintenance-free operation. MACH LED PLUS.forty utilizes state-of-the-art technology to enable optimum lighting in the machining area: the latest LED technology, specially developed optics system and the most modern and robust housing concept in the industry.





(Above) Thru-wire MACH LED PLUS.forty



MACH LED PLUS.forty with 40° angle of illumination



MACH LED PLUS.forty with 90° angle of illumination

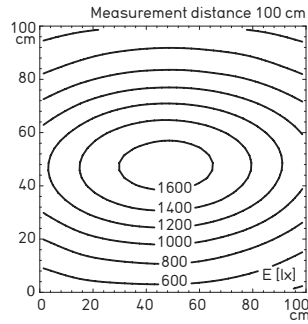

Illuminance taking MLAL 57 S with 40° optics as an example

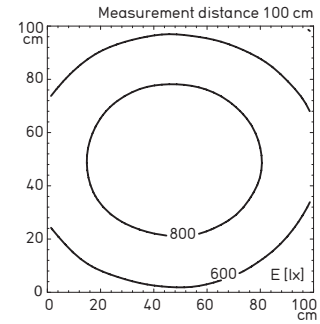

Illuminance taking MLAL 57 S with 90° reflector as an example

**ORDERING INFORMATION** (No operating device included, which is only required for 120-240 VAC operation)

Version	Wattage	Length (A)	Lumens	Model	Part #
<b>20–28 VDC Versions</b>					
90° beam angle	5 W	7.5" (190 mm)	480	MLAL 12 S	113161000-00662575
40° beam angle	5 W	7.5" (190 mm)	490	MLAL 12 S	113161000-00660033
90° beam, thru-wire	5 W	7.5" (190 mm)	480	MLAL 12 SD	113161000-00662600
90° beam angle	10.5 W	14.4" (365 mm)	1080	MLAL 27 S	113162000-00662685
40° beam angle	10.5 W	14.4" (365 mm)	1120	MLAL 27 S	113162000-00660681
90° beam, thru-wire	10.5 W	14.4" (365 mm)	1080	MLAL 27 SD	113162000-00662706
90° beam angle	16 W	21.3" (540 mm)	1680	MLAL 42 S	113163000-00662717
40° beam angle	16 W	21.3" (540 mm)	1720	MLAL 42 S	113163000-00660684
90° beam, thru-wire	16 W	21.3" (540 mm)	1680	MLAL 42 SD	113163000-00662735
90° beam angle	21.5 W	28.2" (715 mm)	2280	MLAL 57 S	113164000-00662806
40° beam angle	21.5 W	28.2" (715 mm)	2330	MLAL 57 S	113164000-00660687
90° beam, thru-wire	21.5 W	28.2" (715 mm)	2280	MLAL 57 SD	113164000-00662833

External Operating Devices	Max. Wattage	Input	Output	Part #
Required for 100-277 VAC	20 W	100-277 VAC, 50/60 Hz	24 VDC	209585029
	50 W	120 VAC, 50/60 Hz	24 VDC	209585030
	96 W	100-277 VAC, 50/60 Hz	24 VDC	209585032

Mounting Options	Item	Unit	Part #
	End bracket set, adjustable, stainless steel +/- 90°	Sold as set	408001403-00671626
	Clip bracket, adjustable, aluminum +/- 20°	Sold individually	408001402-00671623

Accessories	Item	Type	Voltage	Part #
	M12 connector w/ 16' cable assembly (included) straight	A-coded	24 VDC	US0009001
	M12 connector w/ 16' cable assembly, angled	A-coded	24 VDC	US0009011

# LUMATRIS

## HIGH OUTPUT LED MACHINE LIGHT

### FEATURES:

- Six sizes to fit any space
- Flicker-free light with no IR or UV content
- Easy rear or side connection options with M12 connector (included)
- Narrow or wide flood light options
- 50,000 hours maintenance-free operation
- High-pressure IP69K rating

### SPECIFICATIONS:

Voltage	22–26 VDC
Lamping	LED
Color Temperature	5800 K
Color Rendering (CRI)	85
Luminaire Material	anodized aluminum
Lens Material	borosilicate safety glass
Dimensions	various, see chart
Max Temperature Rating	122°F (50°C)
Connection	M12 connector w/ 16' cable assembly (included)
Protection Rating	IP69K
Certification	ETL/cETL, CE
Mounting and accessories	See page 69

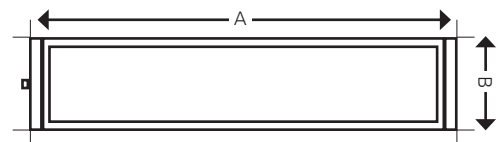
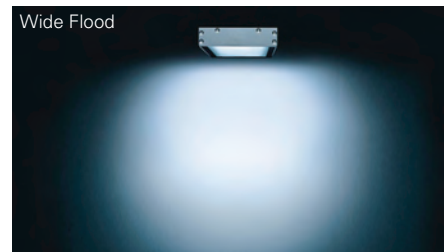
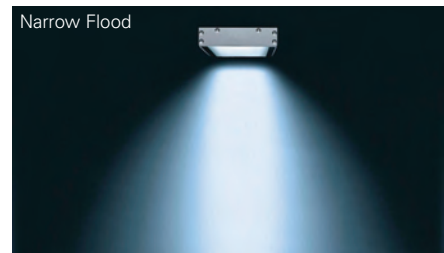

LUMATRIS is designed with the latest in LED technology, combining high light output with specially designed optics to accentuate accessible light without glare or heat. Its 50,000 hours of maintenance-free operation equals energy and cost savings, and the ECO power option on some models allows for even more energy savings – by 30%. High quality materials allow LUMATRIS to keep its efficiency even in machines where temperatures reach up to 122 degrees Fahrenheit. The rugged anodized aluminum housing, along with 4 mm-thick safety glass, helps repel coolants, lubricants – even flying metal chips. It's also impervious to vibration and can safely endure high pressure spray-downs. LUMATRIS is truly the ideal choice for even the most volatile machining environments.

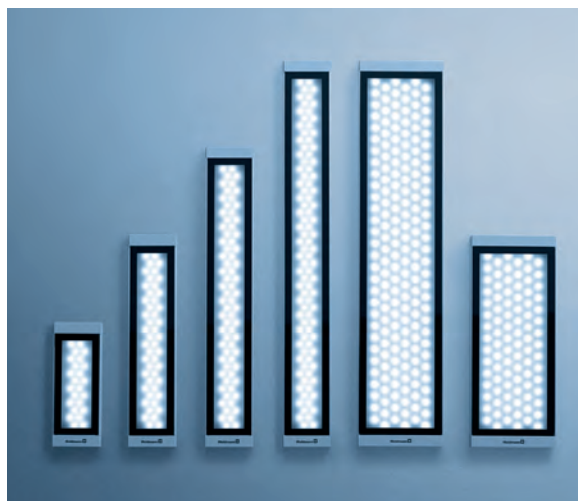

Several Size and Light Output Options



Pivoting Arm Mount



Surface Bracket

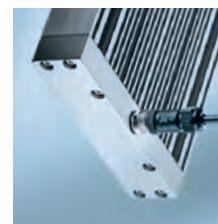

Rear Connection

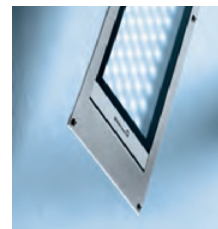

Flush Frame



Side Connection

## ORDERING INFORMATION

Wattage	Length (A)	Width (B)	Connection	Beam Type	Lumens	Model	Part #
8 W	9.7" (246 mm)	3.7"	Side	Narrow	570	MSAL 24 S	113094000-00596722
8 W	9.7" (246 mm)	3.7"	Rear	Narrow	570	MSAL 24 S	113094000-00596788
8 W	9.7" (246 mm)	3.7"	Side	Wide	570	MSAL 24 S	113094000-00596791
8 W	9.7" (246 mm)	3.7"	Rear	Wide	570	MSAL 24 S	113094000-00596794
16 W	16.5" (420 mm)	3.7"	Side	Narrow	1140	MSAL 48 S	113095000-00596761
16 W	16.5" (420 mm)	3.7"	Rear	Narrow	1140	MSAL 48 S	113095000-00596803
16 W	16.5" (420 mm)	3.7"	Side	Wide	1100	MSAL 48 S	113095000-00596806
16 W	16.5" (420 mm)	3.7"	Rear	Wide	1100	MSAL 48 S	113095000-00596809
24 W	23.5" (596 mm)	3.7"	Side	Narrow	1710	MSAL 72 S	113096000-00596764
24 W	23.5" (596 mm)	3.7"	Rear	Narrow	1710	MSAL 72 S	113096000-00596857
24 W	23.5" (596 mm)	3.7"	Side	Wide	1650	MSAL 72 S	113096000-00596862
24 W	23.5" (596 mm)	3.7"	Rear	Wide	1650	MSAL 72 S	113096000-00596870
32 W	30.3" (770 mm)	3.7"	Side	Narrow	2280	MSAL 96 S	113097000-00596767
32 W	30.3" (770 mm)	3.7"	Rear	Narrow	2280	MSAL 96 S	113097000-00596874
32 W	30.3" (770 mm)	3.7"	Side	Wide	2200	MSAL 96 S	113097000-00596877
32 W	30.3" (770 mm)	3.7"	Rear	Wide	2200	MSAL 96 S	113097000-00596880
25 W	16.5" (420 mm)	6.7"	Side	Narrow	1900	MSAL 90 S	112573001-00514271
25 W	16.5" (420 mm)	6.7"	Rear	Narrow	1900	MSAL 90 S	112573000-00499489
25 W	16.5" (420 mm)	6.7"	Side	Wide	1880	MSAL 90 S	112573000-00608666
25 W	16.5" (420 mm)	6.7"	Rear	Wide	1880	MSAL 90 S	112573000-00608673
50 W	30.3" (770 mm)	6.7"	Side	Narrow	3800	MSAL 180 S	112574001-00511140
50 W	30.3" (770 mm)	6.7"	Rear	Narrow	3800	MSAL 180 S	112574000-00499493
50 W	30.3" (770 mm)	6.7"	Side	Wide	3760	MSAL 180 S	112574000-00608680
50 W	30.3" (770 mm)	6.7"	Rear	Wide	3760	MSAL 180 S	112574000-00608677

External Operating Device	Max. Wattage	Input	Output	Part #
	20 W	100-277 VAC, 50/60 Hz	24 VDC	209585029
Required for 100-277 VAC operation	50 W	120 VAC, 50/60 Hz	24 VDC	209585030
	96 W	120-277 VAC, 50/60 Hz	24 VDC	209585032

Mounting Options	Item	Dimensions	Unit	Part #
	45° Rotating surface bracket	3.7" width	set	408001016
	Surface mounting frame	3.7" width	set	408001015-00595587
	Surface mounting frame	6.7" width	set	408001035-00514268
	Pivoting arm mount	any	each	408001033-00514262
	Flush mounting frame	9.7" x 3.7"	each	408001016-00595619
	Flush mounting frame	16.5" x 3.7"	each	408001017-00595613
	Flush mounting frame	23.5" x 3.7"	each	408001018-00595610
	Flush mounting frame	30.3" x 3.7"	each	408001019-00595616
	Flush mounting frame	16.5" x 6.7"	each	408001037-00518121
	Flush mounting frame	30.3" x 6.7"	each	408001034-00514265

Accessories	Item	Type	Power	Part #
	M12 connector w/ 16' cable assembly (included), straight	A-coded	24 VDC	US0009101
	M12 connector w/ 16' cable assembly, angled	A-coded	24 VDC	US0009111

# MACH LED PRO

## FLAT LED MACHINE LIGHT

### FEATURES:

- Small, compact linear housing
- High-performance LED technology
- 50,000 hours maintenance-free operation
- High resistance to coolants/lubricants
- Impervious to mechanical vibration
- Rugged aluminum housing
- Lengths: 8.7" (220 mm), 15.6" (395 mm), 22.4" (570 mm), and 29.3" (745 mm)

### SPECIFICATIONS:

Voltage	24 VDC or VAC
Lamping	LED
Operation	connect to external switch
Color Temperature	5000 K
Color Rendering Index (CRI)	85
Beam Angles	30° or 120°
Luminaire Material	anodized aluminum
Lens Material	borosilicate safety glass
Dimension	4 lengths, 3" wide
Max Temperature Rating	104°F (40°C)
Connection	10' cable with free stranded wires
Protection Rating	IP67
Certification	ETL/cETL, CE
Mounting and accessories	See page 71

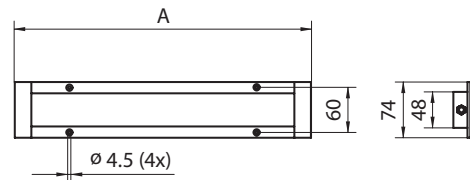

See chart for individual lengths (A)  
Measurements in millimeters

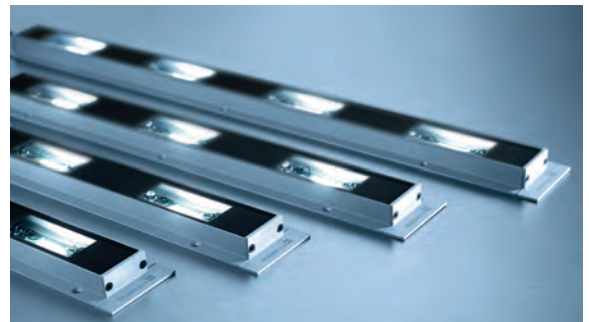

MACH LED PRO provides maximum LED light output using the latest LED chip-array technology, eliminating shadows and distortion of the area being illuminated. With its sealed design and IP67 rating, MACH LED PRO is suitable for both wet and dry locations and delivers maximum luminous power with minimal space intrusion. It can be either flush- or surface-mounted inside the machine housing.

## VERSIONS - FLUSH OR SURFACE MOUNT



## ORDERING INFORMATION - FLUSH MOUNT (No operating device included, which is only required for 100-277 V operation)

Wattage	Voltage	Length (A)	Beam Angle	Lumens	Model	Part #
1 x 6 W	20 - 28 VDC	8.7" (220 mm)	30°	410	MUEL 1 S	112571000-00084579
	20 - 28 VAC, 50/60 Hz	8.7" (220 mm)	30°	410	MUEL 1 S	112571001-00085127
	20 - 28 VDC	8.7" (220 mm)	120°	410	MUEL 1 S	112571002-00085216
	20 - 28 VAC, 50/60 Hz	8.7" (220 mm)	120°	410	MUEL 1 S	112571003-00085194
2 x 6 W	20 - 28 VDC	15.6" (395 mm)	30°	820	MUEL 2 S	112571004-00085220
	20 - 28 VAC, 50/60 Hz	15.6" (395 mm)	30°	820	MUEL 2 S	112571005-00085225
	20 - 28 VDC	15.6" (395 mm)	120°	800	MUEL 2 S	112571006-00085224
	20 - 28 VAC, 50/60 Hz	15.6" (395 mm)	120°	800	MUEL 2 S	112571007-00085226
3 x 6 W	20 - 28 VDC	22.4" (570 mm)	30°	1230	MUEL 3 S	112571010-00085227
	20 - 28 VAC, 50/60 Hz	22.4" (570 mm)	30°	1230	MUEL 3 S	112571011-00085256
	20 - 28 VDC	22.4" (570 mm)	120°	1200	MUEL 3 S	112571012-00085228
	20 - 28 VAC, 50/60 Hz	22.4" (570 mm)	120°	1200	MUEL 3 S	112571013-00085257
4 x 6 W	20 - 28 VDC	29.3" (745 mm)	30°	1640	MUEL 4 S	112571014-00085275
	20 - 28 VAC, 50/60 Hz	29.3" (745 mm)	30°	1640	MUEL 4 S	112571015-00085278
	20 - 28 VDC	29.3" (745 mm)	120°	1600	MUEL 4 S	112571016-00085276
	20 - 28 VAC, 50/60 Hz	29.3" (745 mm)	120°	1600	MUEL 4 S	112571017-00085311

## ORDERING INFORMATION - SURFACE MOUNT (No operating device included, which is only required for 100-277 V operation)

Wattage	Voltage	Length (A)	Beam Angle	Lumens	Model	Part #
1 x 6 W	20 - 28 VDC	8.7" (220 mm)	30°	410	MUAL 1 S	112571020-00079042
	20 - 28 VAC, 50/60 Hz	8.7" (220 mm)	30°	410	MUAL 1 S	112571021-00082249
	20 - 28 VDC	8.7" (220 mm)	120°	400	MUAL 1 S	112571022-00082186
	20 - 28 VAC, 50/60 Hz	8.7" (220 mm)	120°	400	MUAL 1 S	112571023-00082250
2 x 6 W	20 - 28 VDC	15.6" (395 mm)	30°	820	MUAL 2 S	112571024-00082456
	20 - 28 VAC, 50/60 Hz	15.6" (395 mm)	30°	820	MUAL 2 S	112571025-00082632
	20 - 28 VDC	15.6" (395 mm)	120°	800	MUAL 2 S	112571026-00082511
	20 - 28 VAC, 50/60 Hz	15.6" (395 mm)	120°	800	MUAL 2 S	112571027-00082635
3 x 6 W	20 - 28 VDC	22.4" (570 mm)	30°	1230	MUAL 3 S	112571030-00082788
	20 - 28 VAC, 50/60 Hz	22.4" (570 mm)	30°	1230	MUAL 3 S	112571031-00082840
	20 - 28 VDC	22.4" (570 mm)	120°	1200	MUAL 3 S	112571032-00082820
	20 - 28 VAC, 50/60 Hz	22.4" (570 mm)	120°	1200	MUAL 3 S	112571033-00082842
4 x 6 W	20 - 28 VDC	29.3" (745 mm)	30°	1640	MUAL 4 S	112571034-00082844
	20 - 28 VAC, 50/60 Hz	29.3" (745 mm)	30°	1640	MUAL 4 S	112571035-00082863
	20 - 28 VDC	29.3" (745 mm)	120°	1600	MUAL 4 S	112571036-00082846
	20 - 28 VAC, 50/60 Hz	29.3" (745 mm)	120°	1600	MUAL 4 S	112571037-00082866

For installation cutout dimensions of flush mount version, please see MACH LED PRO product specification sheet @ [www.waldmannlighting.com](http://www.waldmannlighting.com)

External Operating Devices	Max. Wattage	Input	Output	Part #
	20 W	100-277 VAC, 50/60 Hz	24 VDC	209585029
Required for 100-277 V operation	50 W	120 VAC, 50/60 Hz	24 VDC	209585030
	96 W	120-277 VAC, 50/60 Hz	24 VDC	209585032

# FLAT LED

## HIGH OUTPUT LED FLOOD LIGHT

### FEATURES:

- Narrow housing depth of only .8" (20 mm)
- Advanced optics to throw wide flood
- Repellent coating protects against heat, wear and corrosion
- High resistance to coolants and lubricants
- Impervious to mechanical vibration
- 50,000 hours maintenance-free operation

### SPECIFICATIONS:

Voltage	10-30 VAC or 10-40 VDC
Lamping	LED
Color Temperature	6500 K
Beam Angle	60°
Luminaire Material	anodized aluminum
Lens Material	borosilicate glass
Dimension	11.2" x 2.9" (284 mm x 74 mm)
Max Temperature Rating	104°F (40°C)
Connection	10' cable with free stranded wires
Protection Rating	IP67
Certification	ETL/cETL
Mounting and accessories	See page 68



FLAT LED was designed with state-of-the-art, high-output LEDs with specially designed optics to produce intense, wide-area illumination in confined spaces. With an overall depth of only 7/8" and the ability to mount flush or on a machine surface, FLAT LED can be used for a variety of applications. With an IP67 rating against oil, steam, water, etc. – it's certified for protection against close-range high pressure spray downs. Intelligent electronics allow FLAT LED to directly connect to 24 VAC or VDC connection, without regard for polarity. The rugged anodized aluminum housing helps dissipate any heat, prolonging LED life. FLAT LED is maintenance-free for up to 50,000 hours at 100% efficiency. Minimal height, maximum luminous power, maintenance-free and energy efficiency make FLAT LED a smart solution for your machine application.



## DIMENSIONAL DATA

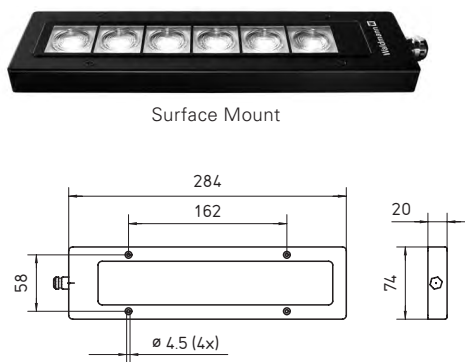

Surface Mount

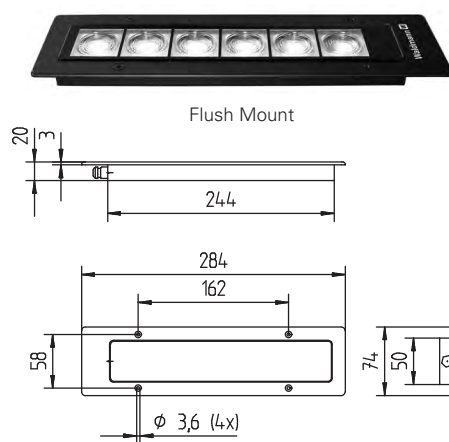

Flush Mount

Measurements in millimeters

## ORDERING INFORMATION

Wattage	Version	Voltage	Lumens	Model	Part #
13 W	Surface	10-40 VDC	510	MYAL 6 S	112560000-00003069
13 W	Flush	10-40 VDC	510	MYEL 6 S	112560001-00003166
13 W	Surface	10-30 VAC	510	MYAL 6 S	112560002-00006272
13 W	Flush	10-30 VAC	510	MYEL 6 S	112560003-00006273
External Operating Devices		Max. Wattage	Input	Output	Part #
		20 W	100-277 VAC, 50/60 Hz	24 VDC	209585029
Required for 100-277 VAC operation		50 W	120 VAC, 50/60 Hz	24 VDC	209585030
		96 W	120-277 VAC, 50/60 Hz	24 VDC	209585032
Mounting Options		Item	Material	Part #	
		Swivel bracket	Galvanized steel	203081019-00019478	

# ROCIA.focus

## HIGH OUTPUT LED SPOT LIGHT

### FEATURES:

- Triple high-powered LED modules
- 60,000 hour maintenance-free operation
- Precision optics with 10° or 40° beam angles
- 5000 K color temperature
- Protection rating up to IP67
- Dimming-capable on arm versions
- High-resistance coating against heat, wear and corrosion
- No stroboscopic effect
- No heat generated in the direction of the light beam

### SPECIFICATIONS:

Voltage	12–40 VDC/12–24 VAC, 100–240 VAC
Lamping	LED
Color Temperature	5000 K
Color Rendering (CRI)	80
Beam Angles	10° or 40°
Luminaire Material	anodized aluminum
Lens Material	3 mm safety glass
Arm Style	24" gooseneck, 27" double arm
Dimensions	3" x 4" head
Max Temperature Rating	low voltage 104°F (40°C) line voltage 77°F (25°C)
Connection	10' cable (NEMA 1-15 on arm versions)
Protection Rating	IP65 and IP67
Certification	ETL/cETL, CE
Mounting and accessories	See page 74



Waldmann's newest industrial-grade spotlight, ROCIA.focus, is constructed from rugged aluminum and is completely sealed for protection from the most volatile machining environments. Available with double arm, gooseneck and pivoting head. All versions offer a choice of either 10° or 40° beam angle. Specially designed optics and high-powered LEDs provide illuminance of up to 30,000 lux with a crisp 5000 K color temperature adding glare-free light and clarity to the machine area. The continuous dimming function allows for adjustments of light levels with flicker-free comfort. Broad-range electronics provide constant light output in a supply voltage range of 12–40 VDC or 12–28 VAC. Double arm and gooseneck versions are also available with integrated power supply for 100–240 VAC operation. In addition, ROCIA.focus boasts up to 90% in energy savings when compared to similar halogen machine lights.





Machine

Task & Workbench

Magnification & Inspection

Facility Lighting

Accessories

**DIMENSIONAL DATA**



Measurements in millimeters

**ORDERING INFORMATION**

Version	Wattage	Voltage	Beam Angle	IP Rating	Lumens	Model	Part #
Double arm	9.5 W	100-240 VAC, 50/60 Hz	10°	IP65	600	RFD 600/850/D	113181000-00680172
Double arm	9.5 W	100-240 VAC, 50/60 Hz	40°	IP65	600	RFD 600/850/D	113181000-00680185
Double arm	8.5 W	12-40 VDC/12-24 VAC	10°	IP67	600	RFD 600/850/DS	113182000-00680110
Double arm	8.5 W	12-40 VDC/12-24 VAC	40°	IP67	600	RFD 600/850/DS	113182000-00680208
Gooseneck arm	9.5 W	100-240 VAC, 50/60 Hz	10°	IP65	600	RFF 600/850/D	113183000-00680254
Gooseneck arm	9.5 W	100-240 VAC, 50/60 Hz	40°	IP65	600	RFF 600/850/D	113183000-00680258
Gooseneck arm	8.5 W	12-40 VDC/12-24 VAC	10°	IP67	600	RFF 600/850/DS	113184000-00680272
Gooseneck arm	8.5 W	12-40 VDC/12-24 VAC	40°	IP67	600	RFF 600/850/DS	113184000-00680285
Pivoting head	8.5 W	12-40 VDC/12-24 VAC	10°	IP67	600	RFJ 600/850/S	113185000-00668613
Pivoting head	8.5 W	12-40 VDC/12-24 VAC	40°	IP67	600	RFJ 600/850/S	113185000-00680293

External Operating Devices	Max. Wattage	Input	Output	Part #
	20 W	100-277 VAC, 50/60 Hz	24 VDC	209585029

Mounting Options	Item	Dimensions	Part #
	Table clamp	0" - 2.75" span	190007019-00014904
	Table clamp	2.5" - 5.4" span	190033019-00014950
	Wall mount	2.4" x 2.8"	300213018-00025178
	Magnetic base	3.3" diameter	190057019-00015056

# ROCIA.planar

## HIGH OUTPUT LED TASK LIGHT

### FEATURES:

- Rugged aluminum housing for long life
- 50,000 hour maintenance-free operation
- Integrated power supply
- Impact resistant cover protects mechanics inside from rough environment
- Protection rating up to IP67
- 3D head joint for precise adjustability
- Rubber switch conveniently located on head
- High-resistance coating against heat, oils
- No stroboscopic effect
- No heat generated in the direction of the light beam
- Sealed IP65 housing

### SPECIFICATIONS:

Voltage	100-240 VAC, 50/60 Hz
Lamping	LED
Color Temperature	5000 K
Color Rendering (CRI)	>80
Luminaire Material	anodized aluminum
Lens Material	satine polycarbonate
Arm Style	27" double arm
Dimensions	3" x 4" head
Connection	10' cable with NEMA 5-15P
Protection Rating	IP65
Certification	ETL/cETL
Mounting and Accessories	See page 74



ROCIA.planar is a robust task light engineered specifically for the industrial environment. With an IP65 sealed housing, the full-metal design protects the inside workings from dust, coolants and oils very often found in these types of areas. Wide area illumination lights up a sizeable space with 5000 K crisp white light. Its 3D head joint and spring-balanced arm guarantee easy positioning and ergonomic comfort. Maintenance-free LED technology offers 50,000 hours of LED life.



Machine

Task & Workbench

Magnification & Inspection

Facility Lighting

Accessories

**DIMENSIONAL DATA**

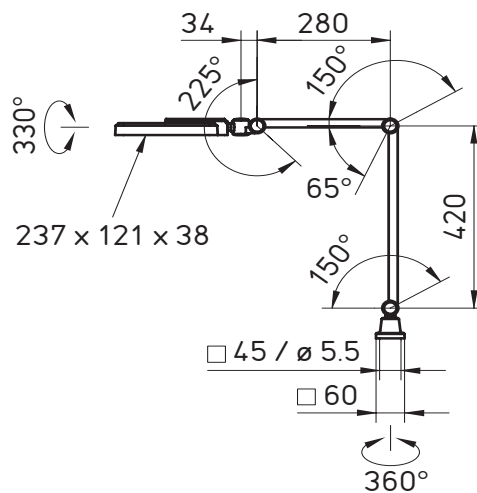

Measurements in millimeters

**ORDERING INFORMATION**

Description	Wattage	Voltage	IP Rating	Lumens	Model	Part #
Double arm	18 W	100-240 VAC	IP65	1500	RPD 1700/850	113458000-00699752
External Operating Devices	Max. Wattage	Input	Output	Part #		
	20 W	100-277 VAC, 50/60 Hz	24 VDC	209585029		
Mounting Options	Item	Dimensions	Part #			
	Table clamp	0 – 2.75"	190007019-00014904			
	Table clamp	2.5" – 5.4"	190033019-00014950			
	Wall mount	2.4" x 2.8"	300213018-00021578			

# RAPTOR

## INDUSTRIAL LED SPOT LIGHT

### FEATURES:

- LED technology
- Universal base included
- Several mounting options
- Robust die-cast aluminum housing
- 3 mm thick safety glass
- High or low voltage options
- Gooseneck or pivoting head models available
- 50,000 hour LED service life
- Withstands temperatures up to 104° F
- ETL/cETL approved

### SPECIFICATIONS:

Voltage	22-28 VDC or 100-240 VAC
Lamping	LED
Color Temperature	5000 K
Beam Angles	10° or 30°
Luminaire Material	aluminum
Lens Material	safety glass
Arm Length (arm version)	22-inch gooseneck
Cable/Plug	10' cable w/free stranded wires
Protection Rating	IP67
Certifications	ETL/cETL
Mounting and accessories	See page 71



RAPTOR LED spotlight impresses with its high-powered LED technology, and 50,000 hours of maintenance-free LED service life. The robust aluminum housing with 3 mm solid safety glass cover stands up to even the toughest machine environments. RAPTOR is available in pivoting head and gooseneck arm versions.



Machine

Task & Workbench

Magnification & Inspection

Facility Lighting

Accessories

**DIMENSIONAL DATA**

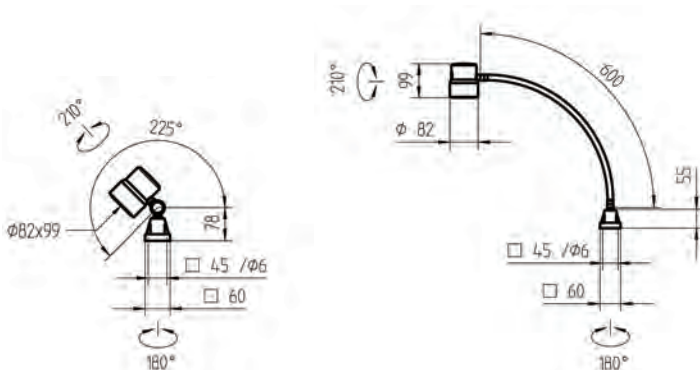

**ORDERING INFORMATION**

Version	Voltage	Wattage	Beam Angle	Model	Part #
Gooseneck	100-240 VAC; 50/60 Hz	6 W	10°	SLF 500/750	113261000-00641180
Gooseneck	100-240 VAC; 50/60 Hz	6 W	30°	SLF 500/750	113261000-00641183
Gooseneck	22-26 VDC	5 W	10°	SLF 500/750/S	113260000-00641130
Gooseneck	22-26 VDC	5 W	30°	SLF 500/750/S	113260000-00641177
Pivoting Head	22-26 VDC	5 W	10°	SLJ 500/750/S	113259000-00641127
Pivoting Head	22-26 VDC	5 W	30°	SLJ 500/750/S	113259000-00641174

External Operating Devices	Max. Wattage	Input	Output	Part #
	20 W	100-277 VAC, 50/60 Hz	24 VDC	209585029

Mounting Options	Item	Dimensions	Part #
	Table Clamp	0" - 2.75" span	190007019-00014904
	Table Clamp	2.5" - 5.4" span	109033019-00014950
	Wall Mount	2.4" x 2.8"	300213018-00025178
	Magnetic Base	3.3" diameter	190057019-00015056

# ABL LED

## COMPACT LED SPOT LIGHT

### FEATURES:

- Compact size provides pinpoint accuracy
- Line- or low-voltage versions available
- High resistance coating against heat, wear and corrosion
- Impervious to mechanical vibration
- Installs via threaded stem or bore and counter nut with standard versions
- 50,000 hours maintenance-free operation

### SPECIFICATIONS:

Voltage with Operating Device	19.2-28.8 V or 95-240 V
Lamping	LED
Color Temperature	6000 K
Beam Angles	6° or 25°
Luminaire Material	anodized aluminum
Lens Material	borosilicate glass
Power Consumption	3 W
Head Dimension	1" diameter x 4.3" deep
Arm Style	30.5" gooseneck
Max Temperature Rating	77°F (25°C)
Connection	Varies by operating device
Protection Rating	IP20/IP67 (see chart)
Mounting and accessories	See page 68



Measurements in millimeters

ABL LED task lights are designed for flexible spot lighting in smaller areas or confined spaces. With a single, high performance, high output LED, the ABL provides pinpoint accuracy and positioning for a wide variety of applications. Available with a gooseneck arm or pivoting head alone, the small size allows for precise positioning to light even the darkest corner or very small area. ABL LED is ideal for illuminating control panels, keyboards, control room equipment, vision systems, manufacturing equipment, test areas and inspection areas. ABL LED can be used inside or outside of a machine and the light itself is IP20/IP67 rated.



## ORDERING INFORMATION

Version	Voltage	IP Rating*	Beam Angle	Op Device Inc.	Lumens	Model	Part #
Gooseneck arm	19.2-28.8 VDC	IP67/IP20	6°	Yes	191	ABLTL 1	112385M20
Gooseneck arm	19.2-28.8 VDC	IP67/IP20	25°	Yes	191	ABLTL 1	112385M21
Gooseneck arm	95-240 VAC	IP67/IP20	6°	Yes	191	ABLTL 1	112385M10
Gooseneck arm	95-240 VAC	IP67/IP20	25°	Yes	191	ABLTL 1	112385M11
Gooseneck arm	Per operating device*	IP67/IP20	6°	No	191	ABLTL 1	112423000-00071550
Gooseneck arm	Per operating device*	IP67/IP20	25°	No	191	ABLTL 1	112423001-00071549
Pivoting head, threadmount	Per operating device*	IP67/IP20	6°	No	191	ABL 1	112353002-00058709
Pivoting head, threadmount	Per operating device*	IP67/IP20	25°	No	191	ABL 1	112353003-00058711

External Operating Devices	Max. Wattage	Input	Output	Part #
	10 W	95-240 VAC, 50/60 Hz	24 VDC	209585019-00045202
*Required	14 W	19.2-28.8 VDC, 50/60 Hz	24 VDC	209582019-00048793

Mounting Options	Description	Dimensions	Part #
	Universal base for table/wall (included)	2.4" x 2.4"	204090019
	Table clamp	0" - 2.75" span	190007019-00014904
	Table clamp	2.5" - 5.4" span	190033019-00014950
	Wall bracket	2.4" x 2.8"	300213018-00025178
	Magnetic base	3.3" diameter	190057019-00015056
	Table base, rectangular	10.5" x 6.7" x 1"	190036109-00058238

\* Luminaire IP67  
Operating device IP20

FOR DETAILED SPECIFICATIONS, PLEASE VISIT [WALDMANNLIGHTING.COM](http://WALDMANNLIGHTING.COM)

Machine

Task & Workbench

Magnification & Inspection

Facility Lighting

Accessories

# HEAD LED

## SURFACE MOUNT LED FLOOD LIGHT

### FEATURES:

- Designed for wide area light distribution
- High resistance to coolants and lubricants
- Impervious to mechanical vibration
- Rugged anodized aluminum housing
- 4 mm safety glass lens
- Narrow or wide flood options
- 50,000 hours maintenance-free operation

### SPECIFICATIONS:

Voltage	16–32 VDC
Lamping	LED
Operation	connect to external source
Color Temperature	5600 K
Beam Angle	70° or 100°
Luminaire Material	anodized aluminum
Lens Material	borosilicate glass
Dimension	1.9" diameter x .9"
Power Consumption	11 W
Mounting	surface mounted
Connection	M12 connector w/ 8" cable assembly
Protection Rating	IP67
Certification	ETL/cETL
Accessories	See page 68

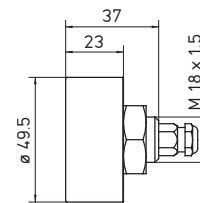

Measurements in millimeters

HEAD LED is an LED flood light designed for integration into machines and equipment requiring a fixed, high-output light beam. The no-nonsense unit has been reduced to its most essential features - without losing luminous power and lighting quality. As a result, HEAD LED can be easily integrated into custom applications and mounting positions. HEAD LED measures just under one inch in height and less than two inches in diameter. There is no space too small for HEAD LED. This small luminaire can light up an entire machine with its 70° or 100° (narrow or wide) flood. It is also impact and vibration resistant, ideal for any machining environment.



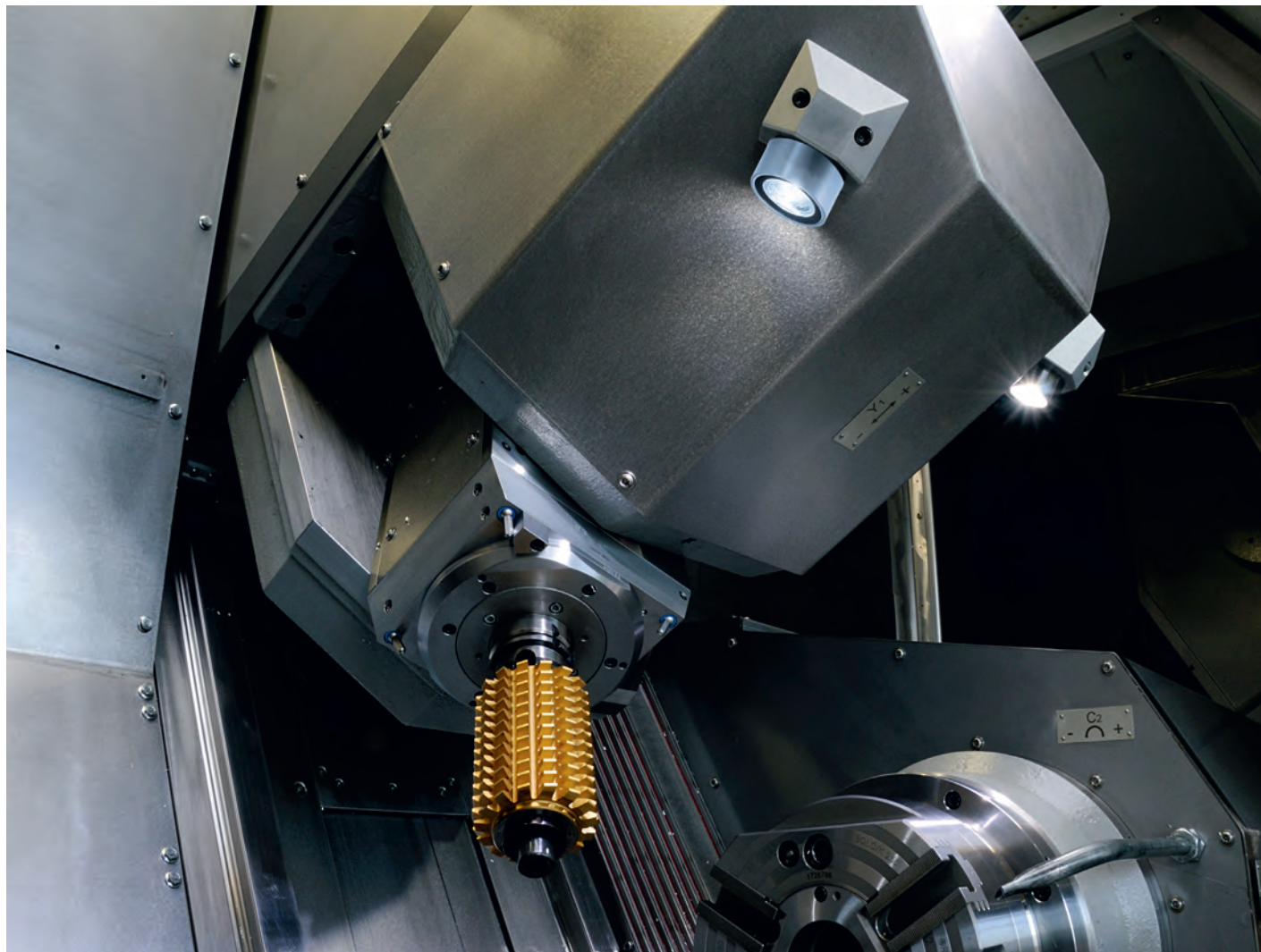

Machine

Task &amp; Workbench

Magnification &amp; Inspection

Facility Lighting

Accessories

#### ORDERING INFORMATION

Version	Beam Angle	Wattage	Lumens	Model	Part #
Wide Flood	100°	11 W	805	MCAYL 4 S	113155000-00646485
Narrow Flood	70°	11 W	805	MCAYL 4 S	113155000-00669609
External Operating Device	Max. Wattage	Input	Output	Part #	
Required for 100-277 VAC operation	20 W	100-277 VAC	24 VDC	209585029	
Accessories	Item	Type	Part #		
	M12 connector plug, straight (included)	A-coded	330603020-00002947		

# ONE LED

## COMPACT LED FLOOD LIGHT

### FEATURES:

- Housing size:  
H 1.4" (36 mm) x W 1.2" (30 mm) x L 6.4" (163 mm)
- Surface-mount LED flood light
- Latest LED chip-array technology
- Safety glass or PMMA acrylic lens
- Die-cast, heat-sink housing
- Easy to install and connect
- Available with or without mounting bracket
- 50,000 hours maintenance-free operation
- Designed to withstand difficult conditions
- Impervious to shock and vibration
- Ideal for small machining compartments

### SPECIFICATIONS:

Voltage	20-28 VDC
Lamping	LED
Operation	connect to external source
Color Temperature	5000 K
Color Rendering Index (CRI)	65
Beam Angle	170°
Luminaire Material	pressure cast aluminum
Lens Material	borosilicate glass or acrylic lens
Power Consumption	6 W
Max Temperature Rating	122°F (50°C)
Connection	tool-free connector, cable not included
Protection Rating	IP67 (glass) or IP54 (acrylic)
Certification	ETL/cETL
Accessories	See page 71



Cable not included



ONE LED was developed with the purpose of providing maximum light with a minimal, no-frills housing. Designed as an all-purpose, robust LED area light, ONE LED can be used in the most confined spaces. The luminaire body acts as a heat-sink to dissipate heat away from the beam direction. ONE LED provides maximum LED light output using the latest LED chip-array technology. Despite its minimal housing design, ONE LED can operate at ambient temperatures of up to 122°F (50°C). ONE LED is suitable for many industrial applications including printing presses, drill presses, machine compartments and production equipment with minimal space and high operating temperatures. The connection is fast and easy with the Quickon connection system. ONE LED is also resistant to shock, vibration and continuous impact so prevalent in production and manufacturing environments.



Machine

Task & Workbench

Magnification & Inspection

Facility Lighting

Accessories

**DIMENSIONAL DATA**

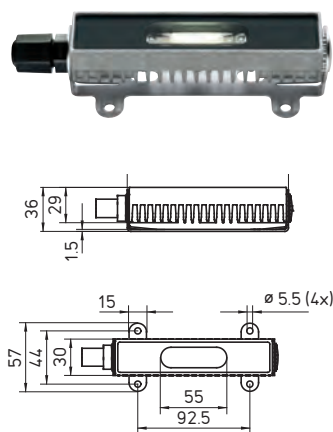

ONE LED with bracket

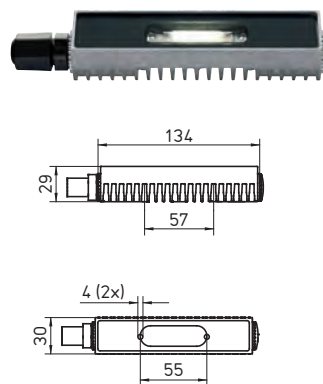

ONE LED without bracket

Measurements in millimeters

**ORDERING INFORMATION**

Wattage	Lens Material	Mounting Bracket	Protection Rating	Lumens	Model	Part #
6 W	Borosilicate glass	Included	IP67	400	MVAL 1 S	112887037-00076065
6 W	Borosilicate glass	Not included	IP67	400	MVAL 1 S	112887034-00076059
6 W	PMMA acrylic	Included	IP54	400	MVAL 1 S	112887027-00076050
6 W	PMMA acrylic	Not included	IP54	400	MVAL 1 S	112887024-00076049

External Operating Devices	Max. Wattage	Input	Output	Part #
Required for 100-277 V operation	20 W	100-277 VAC, 50/60 Hz	24 VDC	209585029
	50 W	120 VAC, 50/60 Hz	24 VDC	209585030
	96 W	120-277 VAC, 50/60 Hz	24 VDC	209585032

# SLIM LED

## COMPACT LINEAR LED LIGHT

### FEATURES:

- Small, compact linear housing less than one inch (22 mm) wide
- Five lengths and light output options
- Adjustable housing version rotates 45°
- Aluminum extruded housing
- Impact and vibration resistant
- 50,000 hours maintenance-free operation

### SPECIFICATIONS:

Voltage	22–29 VDC
Lamping	LED
Color Temperature	5400 K
Beam Angles	adjustable beam direction +/- 45°
Luminaire Material	anodized aluminum
Lens Material	acrylic: clear, satine or no lens
Dimension	varied lengths, less than 1" wide
Mounting	adjustable or fixed housing
Max Temperature Rating	104°F (40°C)
Connection	10' cable with free stranded wires (included)
Protection Rating	IP67*
Certification	ETL/cETL
Accessories	See page 74

**\*NOTE: NOT SUITABLE FOR USE  
WITH COOLANTS OR LUBRICANTS**



SLIM LED is a family of compact, low-profile LED luminaires designed for both interior and exterior applications. Optimal linear flood lighting is delivered using the latest technology in which the LEDs are directly attached to a flexible circuit board. The sleek profile of SLIM LED allows adjustability up to 45° in either direction and five different lengths offer installation flexibility for a wide variety of applications. The compact size allows for easy integration into an existing system, while providing exceptional energy efficiency, low-voltage safety and numerous design possibilities.

**\*PLEASE NOTE: Although SLIM LED is completely waterproof, it is not suitable for use with coolants or lubricants.**



## DIMENSIONAL DATA

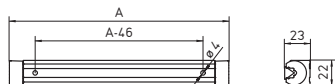

SLIM LED +/- 45° Adjustable Housing

Measurements in millimeters

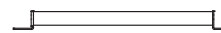
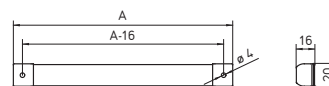

SLIM LED with Flange

## ORDERING INFORMATION

Wattage	Length (A)	Mounting Style	Lens Type	Lumens	Model	Part #
3.5 W	7.7" (196 mm)	Adjustable	Clear	186	LIQ 6	112544000-00001328
3.5 W	7.7" (196 mm)	Adjustable	Satine	186	LIQ 6	112544005-00011100
3.5 W	7.7" (196 mm)	Adjustable	No lens	186	LIQ 6	112544010-00011101
3.5 W	7.7" (196 mm)	Non-adjustable w/ flange	Clear	186	LIQ 6	112545000-00001351
3.5 W	7.7" (196 mm)	Non-adjustable w/ flange	Satine	186	LIQ 6	112545005-00011120
3.5 W	7.7" (196 mm)	Non-adjustable w/ flange	No lens	186	LIQ 6	112545010-00011121
7 W	13.2" (336 mm)	Adjustable	Clear	372	LIQ 12	112544001-00011081
7 W	13.2" (336 mm)	Adjustable	Satine	372	LIQ 12	112544006-00011088
7 W	13.2" (336 mm)	Adjustable	No lens	372	LIQ 12	112544011-00011102
7 W	13.2" (336 mm)	Non-adjustable w/ flange	Clear	372	LIQ 12	112545001-00011125
7 W	13.2" (336 mm)	Non-adjustable w/ flange	Satine	372	LIQ 12	112545006-00011128
7 W	13.2" (336 mm)	Non-adjustable w/ flange	No lens	372	LIQ 12	112545011-00011129
14 W	24.3" (616 mm)	Adjustable	Clear	744	LIQ 24	112544002-00011082
14 W	24.3" (616 mm)	Adjustable	Satine	744	LIQ 24	112544007-00011085
14 W	24.3" (616 mm)	Adjustable	No lens	744	LIQ 24	112544012-00011103
14 W	24.3" (616 mm)	Non-adjustable w/ flange	Clear	744	LIQ 24	112545002-00011130
14 W	24.3" (616 mm)	Non-adjustable w/ flange	Satine	744	LIQ 24	112545007-00011131
14 W	24.3" (616 mm)	Non-adjustable w/ flange	No lens	744	LIQ 24	112545012-00011132
21 W	35.3" (896 mm)	Adjustable	Clear	1116	LIQ 36	112544003-00011083
21 W	35.3" (896 mm)	Adjustable	Satine	1116	LIQ 36	112544008-00011086
21 W	35.3" (896 mm)	Adjustable	No lens	1116	LIQ 36	112544013-00011104
21 W	35.3" (896 mm)	Non-adjustable w/ flange	Clear	1116	LIQ 36	112545003-00011133
21 W	35.3" (896 mm)	Non-adjustable w/ flange	Satine	1116	LIQ 36	112545008-00011134
21 W	35.3" (896 mm)	Non-adjustable w/ flange	No lens	1116	LIQ 36	112545013-00011135
28 W	46.3" (1176 mm)	Adjustable	Clear	1488	LIQ 48	112544004-00011084
28 W	46.3" (1176 mm)	Adjustable	Satine	1488	LIQ 48	112544009-00011087
28 W	46.3" (1176 mm)	Adjustable	No lens	1488	LIQ 48	112544014-00011105
28 W	46.3" (1176 mm)	Non-adjustable w/ flange	Clear	1488	LIQ 48	112545004-00011136
28 W	46.3" (1176 mm)	Non-adjustable w/ flange	Satine	1488	LIQ 48	112545009-00011137
28 W	46.3" (1176 mm)	Non-adjustable w/ flange	No lens	1488	LIQ 48	112545014-00011138

External Operating Devices	Max. Wattage	Input	Output	Part #
Required for 100-277 V operation	20 W	100-277 VAC, 50/60 Hz	24 VDC	209585029
	50 W	120 VAC, 50/60 Hz	24 VDC	209585030
	96 W	120-277 VAC, 50/60 Hz	24 VDC	209585032

# RL70LE

## INDUSTRIAL LED TUBE LIGHT

### FEATURES:

- New LED generation designed as an update for conventional fluorescent industrial tube lights
- Premium LED materials and technology offer 50,000 hours of maintenance-free operation
- Clear acrylic is strong for machining and other industrial environments
- Robust polycarbonate option ideal for food industry
- Several lengths designed to act as direct replacements for existing tube lights
- Protective-grade borosilicate glass versions resist coolants, lubricants and other volatile liquids
- Wide light opening along length of fixture
- ETL/cETL approved

### SPECIFICATIONS:

Voltage	22-26 VDC
Lamping	LED
Color Temperature	5000 K
Color Rendering Index (CRI)	>80
Beam Angle	120°
Tube Material	acrylic, glass or polycarbonate
Dimension	2.75" diameter, various lengths
Max Temperature Rating	104°F (40°C)
Connection	terminal block, cable not included
Protection Rating	IP67
Certification	ETL/cETL
Mounting and accessories	See page 72

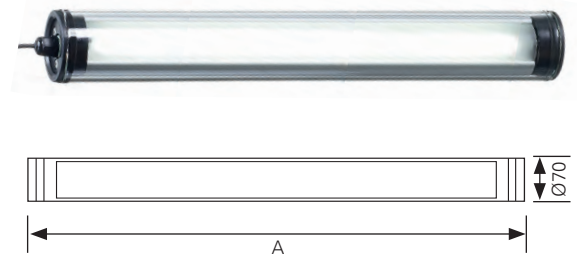

RL70LE takes the traditional model of the industrial tube light and improves it with the added advantages that LED brings to the industry. Strong borosilicate glass, impact-resistant acrylic, or polycarbonate surrounds, sealed IP67 construction, and a bright 5000 K light, assure a solid, reliable product. 50,000 hours of maintenance-free LED operation expands lamp life significantly from fluorescents, making it ideal for those hard-to-reach areas. Available in six lengths and a choice of tube materials and mounting options, RL70LE is an ideal choice for virtually any application where strength and dependability are crucial.

Please contact factory for polycarbonate options.

**ORDERING INFORMATION**

Length (A)	Tube Type	Thru-Wiring	Wattage	Lumens	Model	Part #
14.6"	Glass	No	12.5 W	950	RL70LE 24 N	113279000-00641386
14.6"	Acrylic	No	12.5 W	950	RL70LE 24 N	113279000-00712020
14.6"	Acrylic	Yes	12.5 W	950	RL70LE 24 DN	113513000-00722105
20"	Glass	No	19 W	1400	RL70LE 36 N	113280000-00641389
20"	Acrylic	No	19 W	1400	RL70LE 36 N	113280000-00712023
20"	Acrylic	Yes	19 W	1400	RL70LE 36 DN	113514000-00722108
25.6"	Glass	No	25 W	1900	RL70LE 48 N	113281000-00641392
25.6"	Acrylic	No	25 W	1900	RL70LE 48 N	113281000-00712026
25.6"	Acrylic	Yes	25 W	1900	RL70LE 48 DN	113515000-00722111
31"	Glass	No	31.5 W	2400	RL70LE 60 N	113282000-00641395
31"	Acrylic	No	31.5 W	2400	RL70LE 60 N	113282000-00712029
31"	Acrylic	Yes	31.5 W	2400	RL70LE 60 DN	113516000-00722114
42"	Glass	No	44 W	3300	RL70LE 84 N	113283000-00641398
42"	Acrylic	No	44 W	3300	RL70LE 84 N	113283000-00712032
42"	Acrylic	Yes	44 W	3300	RL70LE 84 DN	113517000-00722117
47.6"	Glass	No	50 W	3800	RL70LE 96 N	113284000-00641401
47.6"	Acrylic	No	50 W	3800	RL70LE 96 N	113284000-00712036
47.6"	Acrylic	Yes	50 W	3800	RL70LE 96 DN	113518000-00722121

**MOUNTING ACCESSORIES**

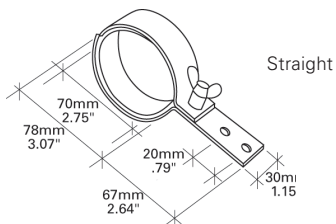

Straight



Long L

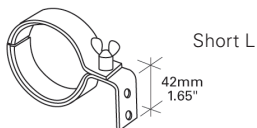

Short L

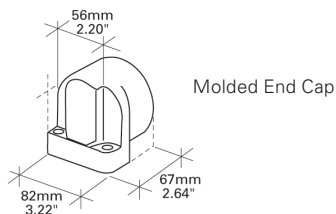

Molded End Cap

Item	Bracket Material	Insert Material	Part #
Bracket, straight	Galvanized Steel	Neoprene	190015019-00014930
Bracket, long-L	Galvanized Steel	Neoprene	SK1021019-00010286
Bracket, short-L	Galvanized Steel	Neoprene	190015995
Bracket, straight	Galvanized Steel	Profiled rubber	190015719-00085498
Bracket, long-L	Galvanized Steel	Profiled rubber	SK1021719-00085499
Bracket, short-L	Galvanized Steel	Profiled rubber	SK0995719-00085652
Bracket, straight	Stainless Steel	Neoprene	190180019-00092731
Bracket, long-L	Stainless Steel	Neoprene	190183019-00093961
Bracket, short-L	Stainless Steel	Neoprene	190181019-00092728
Bracket, straight	Stainless Steel	Profiled rubber	190180719-00092730
Bracket, long-L	Stainless Steel	Profiled rubber	190169719-00089351
Bracket, short-L	Stainless Steel	Profiled rubber	190181719-00092729
Strap	Galvanized Steel	na	190027019-00057337
End caps (set of 2)	Black plastic	na	US0165012

\*All RL models require 2 mounting brackets per fixture unless otherwise noted

External Operating Devices	Max Wattage	Input	Output	Part #
	20 W	100-277 VAC; 50/60 Hz	24 VDC	209585029
	50 W	120 VAC; 50/60 Hz	24 VDC	209585030
	96 W	120-277 VAC; 50/60 Hz	24 VDC	209585032

# RL70

## INDUSTRIAL FLUORESCENT TUBE LIGHT

### FEATURES:

- RL70CE Series - compact fluorescent lamps and electronic ballast
- RL70E Series - T5, T5HO and T8 LFL lamps, electronic ballast
- RL70S Series - T5 CFL and T8 LFL remote ballast applications, ballast not included
- "All-In-One" models are pre-wired with electronic ballast, 8ft cable set and brackets
- "H" models include piggyback, low-profile electronic ballasts, louver and end caps

### SPECIFICATIONS:

Voltage	24 VAC or 24 VDC, 120-277 VAC, 50/60 Hz
Lamping	CFL, T5, T5HO, T8, fluorescent
Operation	connect to external source
Color Temperature	4100 K
Tube Material	acrylic or borosilicate glass
Dimension	2.75" (70 mm) diameter, various lengths
Max Temperature Rating	104°F (40°C)
Connection	only on specified models
Protection Rating	IP67
Certification	ETL/cETL
Mounting and accessories	See page 73

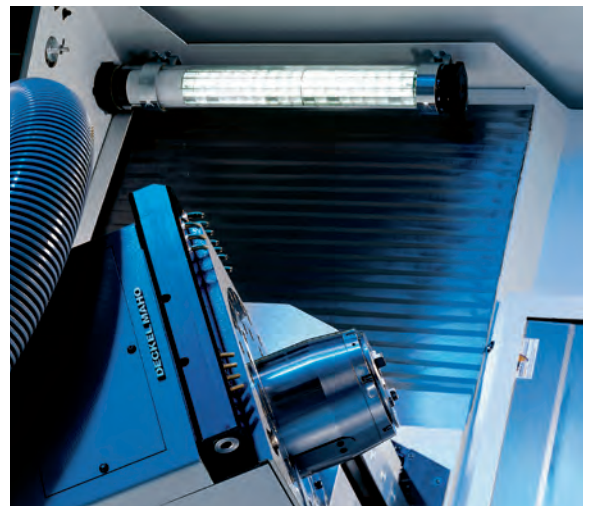

The RL70 industrial tube light provides broad, wide area illumination inside the machine compartment and is ideal for areas requiring a high output, linear fluorescent light source. This durable, sealed (IP67 rated) luminaire is available in varying lengths, with a variety of mounting options to fit a wide range of applications. Available with either glass or acrylic tubes, the RL70 is designed to illuminate hard to reach areas too small for traditional luminaire mounting. It is designed to be impervious to debris, coolants and lubricants found inside the machine compartment. With a wide range of sizes, variants and mounting accessories, RL70 installs easily in a variety of equipment, machine compartments and enclosures. They are available in lengths from 14" to 67" and provide powerful, glare-free illumination. Low-voltage models are also available in 24 VAC or VDC for improved safety and connection to an existing 24 V power supply on the machine.



**RL70 C SERIES (CFL and electronic ballasts)**

Length	Voltage	Tube	Lamping	Lumens	Model	Part #
18.9" (480 mm)	120 VAC; 50/60 Hz	Acrylic	18 WT5 CFL	1250	RL70CE-118	041803016-00006993
18.9" (480 mm)	120 VAC; 50/60 Hz	Glass	18 WT5 CFL	1250	RL70CE-118	041803015-00080014
20.6" (524 mm)	24 VDC	Acrylic	18 WT5 CFL	1250	RL70CE-118	112370000-00084157
20.6" (524 mm)	24 VDC	Glass	18 WT5 CFL	1250	RL70CE-118	112370001-00084161
20.6" (524 mm)	24 VAC; 50/60 Hz	Acrylic	18 WT5 CFL	1250	RL70CE-118	112369000-00084194
20.6" (524 mm)	24 VAC; 50/60 Hz	Glass	18 WT5 CFL	1250	RL70CE-118	112369001-00084204
26.7" (679 mm)	120-277 VAC; 50/60 Hz	Acrylic	24 WT5 CFL	2000	RL70CE-124	108670000-00081448
26.7" (679 mm)	120-277 VAC; 50/60 Hz	Glass	24 WT5 CFL	2000	RL70CE-124	108670001-00081450
26.7" (679 mm)	120-277 VAC; 50/60 Hz	Acrylic	24 WT5 CFL	2000	RL70CE-124	108670M00*
26.7" (679 mm)	120-277 VAC; 50/60 Hz	Glass	24 WT5 CFL	2000	RL70CE-124	108670M01*
19.5" (495 mm)	100-280 VAC; 50/60 Hz	Acrylic	24 WT5 CFL	2000	RL70CE-124H	112913010-00488729**
19.5" (495 mm)	100-280 VAC; 50/60 Hz	Glass	24 WT5 CFL	2000	RL70CE-124H	112913011-00488735**
25.2" (639 mm)	24 VDC	Acrylic	24 WT5 CFL	2000	RL70CE-124	111440000-00057173
25.2" (639 mm)	24 VDC	Glass	24 WT5 CFL	2000	RL70CE-124	111440001-00057175
25.2" (639 mm)	24 VAC; 50/60 Hz	Acrylic	24 WT5 CFL	2000	RL70CE-124	111410000-00057156
25.2" (639 mm)	24 VAC; 50/60 Hz	Glass	24 WT5 CFL	2000	RL70CE-124	111410001-00057158
31" (788 mm)	120-277 VAC; 50/60 Hz	Acrylic	36 WT5 CFL	2900	RL70CE-136	108680000-00081455
31" (788 mm)	120-277 VAC; 50/60 Hz	Glass	36 WT5 CFL	2900	RL70CE-136	108680001-00081457
31" (788 mm)	120-277 VAC; 50/60 Hz	Acrylic	36 WT5 CFL	2900	RL70CE-136	108680M00*
31" (788 mm)	120-277 VAC; 50/60 Hz	Glass	36 WT5 CFL	2900	RL70CE-136	108680M01*
23" (584 mm)	110-230 VAC; 50/60 Hz	Acrylic	36 WT5 CFL	2900	RL70CE-136H	619063010-00077590**
23" (584 mm)	110-230 VAC; 50/60 Hz	Glass	36 WT5 CFL	2900	RL70CE-136H	619063011-00005922**
29.4" (747 mm)	24 VDC	Acrylic	36 WT5 CFL	2900	RL70CE-136	111450000-00064046
29.4" (747 mm)	24 VDC	Glass	36 WT5 CFL	2900	RL70CE-136	111450001-00057177
29.4" (747 mm)	24 VAC; 50/60 Hz	Acrylic	36 WT5 CFL	2900	RL70CE-136	111420000-00057161
29.4" (747 mm)	24 VAC; 50/60 Hz	Glass	36 WT5 CFL	2900	RL70CE-136	111420001-00057164

**Types of Fluorescent Lamps**

Compact Fluorescent (CFL)



T8 Fluorescent (LFL)

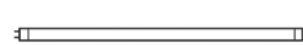

T5 and T5HO Fluorescents (LFL)

\* All-in-one model, includes short-L brackets and 8 ft cable set

\*\* Piggyback ballast (ballast located behind lamps), w/ louver; no cable or bracket

**RL70 E SERIES** (For standard bi-pin T5 & T8 lamps)

Length	Voltage	Tube	Lamping	Lumens	Model	Part #
36.2" (919 mm)	24 VDC	Acrylic	F18T8	1600	RL70E-118	111690000-00063406
36.2" (919 mm)	24 VDC	Glass	F18T8	1600	RL70E-118	111690001-00063408
36.2" (919 mm)	24 VAC; 50/60 Hz	Acrylic	F18T8	1600	RL70E-118	111650000-00063029
36.2" (919 mm)	24 VAC; 50/60 Hz	Glass	F18T8	1600	RL70E-118	111650001
40.6" (1030 mm)	120-277 VAC; 50/60 Hz	Acrylic	F17T8	1400	RL70E-117	128100000-00084831
40.6" (1030 mm)	120-277 VAC; 50/60 Hz	Glass	F17T8	1400	RL70E-117	128100001-00084832
40.6" (1030 mm)	120-277 VAC; 50/60 Hz	Acrylic	F17T8	1400	RL70E-117	128100900*
40.6" (1030 mm)	120-277 VAC; 50/60 Hz	Glass	F17T8	1400	RL70E-117	128100901*
41.2" (1047 mm)	120-277 VAC; 50/60 Hz	Acrylic	2 x 24 W T5HO	4000	RL70E-224	138451000-00019665
41.2" (1047 mm)	120-277 VAC; 50/60 Hz	Glass	2 x 24 W T5HO	4000	RL70E-224	138451001-00019672
52.6" (1335 mm)	120-277 VAC; 50/60 Hz	Acrylic	F25T8	2500	RL70E-125	128110000-00084833
52.6" (1335 mm)	120-277 VAC; 50/60 Hz	Acrylic	F25T8	2500	RL70E-125	128110900*
60.3" (1532 mm)	24 VDC	Acrylic	F36T8	2900	RL70E-136	111730000-00059987
60.3" (1532 mm)	24 VDC	Glass	F36T8	2900	RL70E-136	111730001-00059991
60.3" (1532 mm)	24 VAC; 50/60 Hz	Acrylic	F36T8	2900	RL70E-136	111720000-00059978
60.3" (1532 mm)	24 VAC; 50/60 Hz	Glass	F36T8	2900	RL70E-136	111720001-00059980
52.7" (1338 mm)	120-277 VAC; 50/60 Hz	Acrylic	2 x 39 W T5HO	7000	RL70E-239	138450000-00019726
52.7" (1338 mm)	120-277 VAC; 50/60 Hz	Glass	2 x 39 W T5HO	7000	RL70E-239	138450001-00019727
65.2" (1656 mm)	120-277 VAC; 50/60 Hz	Acrylic	F32T8	2900	RL70E-132	128120000-00084835
65.2" (1656 mm)	120-277 VAC; 50/60 Hz	Glass	F32T8	2900	RL70E-132	128120001-00084836
65.2" (1656 mm)	120-277 VAC; 50/60 Hz	Acrylic	F32T8	2900	RL70E-132	128120900*
65.2" (1656 mm)	120-277 VAC; 50/60 Hz	Glass	F32T8	2900	RL70E-132	128120901*
67.4" (1711 mm)	100-280 V; 50/60 Hz	Glass	2 x 54 W T5HO	10000	RL70E-254	138491001-00488841

\* All-in-one model, includes built-in brackets and 8 ft cable set

**RL70 S SERIES** (For use w/ remote ballast, to be purchased separately)

Length	Voltage	Tube	Lamping	Lumens	Model	Part #
14.4" (367 mm)	per remote ballast	Acrylic	18 W T5 CFL	1250	RL70-118 S	108210000-00055526
20.7" (525 mm)	per remote ballast	Glass	36 W T5 CFL	2900	RL70-136 S	108620001-00013818
30.9" (784 mm)	per remote ballast	Acrylic	17 W T8 LFL	1400	RL70-117 S	128130000-00084837
30.9" (784 mm)	per remote ballast	Glass	17 W T8 LFL	1400	RL70-117 S	128130001
54.9" (1394 mm)	per remote ballast	Acrylic	32 W T8 LFL	2950	RL70-132 S	128150000-00084841

## MOUNTING ACCESSORIES

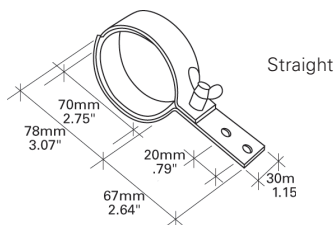

Straight



Long-L

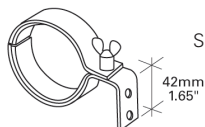

Short-L

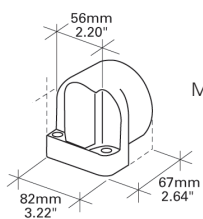

Molded End Cap

Item	Bracket Material	Insert Material	Part #
Bracket, straight	Galvanized steel	Neoprene	190015019-00014930
Bracket, long-L	Galvanized steel	Neoprene	SK1021019-00010286
Bracket, short-L	Galvanized steel	Neoprene	190015995
Bracket, straight	Galvanized steel	Profiled rubber	190015719-00085498
Bracket, long-L	Galvanized steel	Profiled rubber	SK1021719-00085499
Bracket, short-L	Galvanized steel	Profiled rubber	SK0995719-00085652
Bracket, straight	Stainless steel	Neoprene	190180019-00092731
Bracket, long-L	Stainless steel	Neoprene	190183019-00093961
Bracket, short-L	Stainless steel	Neoprene	190181019-00092728
Bracket, straight	Stainless steel	Profiled rubber	190180719-00092730
Bracket, long-L	Stainless steel	Profiled rubber	190169719-00089351
Bracket, short-L	Stainless steel	Profiled rubber	190181719-00092729
End Caps (set of two)	Black plastic	na	US0165012

\*All RL models require 2 mounting brackets per fixture unless otherwise noted

## REMOTE BALLASTS FOR S SERIES

Wattage	For Use With	Voltage	Part #
1x24/39 W or 2x24/39 W	T5 LFL	120-277 VAC; 50/60 Hz	309361050-00092219
1x18/24/36 W or 2x18/24/36 W	T5 CFL	120-277 VAC; 50/60 Hz	309439010-00093716
1x17/25/32 W	T8 LFL	120-277 VAC; 50/60 Hz	309368010

## RL70 REPLACEMENT LAMPS

Item	Base	Lumens	Length	Part #
17 WT8 LFL	G13	1400	23.9" (609 mm)	450017020
18 WT5 CFL	2G11	1250	9" (229 mm)	450018010
24 WT5 CFL	2G11	2000	22" (559 mm)	450024M10
25 WT8 LFL	G13	2225	35.9" (914 mm)	450025020
32 WT8 LFL	G13	2950	47.9" (1219 mm)	450032020
36 WT5 CFL	2G11	2900	16.5" (419 mm)	450036M10
36 WT8LFL	G13	3350	47.2" (1200 mm)	450036013-00051081
24 WT5HO LFL	G5	2000	22.2" (563 mm)	450024M12
39 WT5HO LFL	G5	3500	34" (864 mm)	450039012
54 WT5HO LFL	G5	5000	45.9" (1168 mm)	450054012

# AWD

## COMPACT WATERPROOF INDUSTRIAL TUBE LIGHT

### FEATURES:

- Water-tight protection rating of IP67
- Long-term protection against coolants, lubricants
- Borosilicate glass tube for extra protection
- Fiberglass-reinforced polyamide body
- Steel conduit thread screw for quick connections and easy installation

### SPECIFICATIONS:

Voltage	24 VDC
Lamping	LED or CFL
Operation	connect to external source
Color Temperature	5000 K LED; 4100 K CFL
Color Rendering Index (CRI)	80
Luminaire Material	fiberglass-reinforced polyamide
Tube Material	borosilicate glass
Mounting	2-prong connector/thread mount
Power Consumption	5.5 W LED; 18 W CFL
Dimension	10" length, 2.75" diameter
Max Temperature Rating	104°F (40°C)
Connection	terminal block, cable not included
Protection Rating	IP67
Accessories	See page 68



AWD is ideal for smaller industrial applications requiring a compact, high-output luminaire with integral glare control. These 10-inch tubular luminaires are available with or without louvers, in LED or fluorescent versions. AWD is IP67 rated; completely sealed against dust, water, and petroleum-based fluids, and is constructed to withstand the impact of flying debris and hot metal chips as well as harsh vibrations prevalent in machining environments.



Machine

Task &amp; Workbench

Magnification &amp; Inspection

Facility Lighting

Accessories

## DIMENSIONAL DATA



AWDL1 LED



AWDCE-118 fluorescent (with louver)

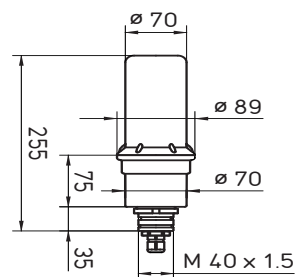

Measurements in millimeters

## ORDERING INFORMATION

Wattage	Voltage	Tube Type	Length	Louver Incl.	Lumens	Model	Part #
5.5 W	24 VDC	Glass	10" (255 mm)	No	300	AWDL1	112950000-00521546
18 W	24 VDC	Glass	10" (255 mm)	No	1200	AWDCE-118	112153001-00083632
18 W	24 VDC	Glass	10" (255 mm)	Yes	1200	AWDCE-118	112153011-00083633

Mounting Option	Item	Material	Color	Part #
	Wall bracket	Hardened plastic	Black	191092019-00086727

Replacement Lamp	Item	Base	Lumens	Part #
	18 W CFL	G24Q2	1200	450018182



## INDUSTRIAL LIGHTING | TASK & WORKBENCH

<b>TANEO</b> - ARM -MOUNTED AND SYSTEM LED LUMINAIRE	<b>40 - 41</b>
<b>TAMETO</b> - WORKSTATION LIGHTING	<b>42 - 43</b>
<b>WLA</b> - LED WORKSTATION LIGHT	<b>44 - 45</b>
<b>ALD</b> - LED WORKSTATION LIGHT	<b>46 - 47</b>
<b>SNE</b> - UNIVERSAL INDUSTRIAL TASK LIGHT	<b>48 - 49</b>

Machine

Task &amp; Workbench

Magnification &amp; Inspection

Facility Lighting

Accessories

# TANEO

## LED LUMINAIRE

### FEATURES:

- Power consumption 14 W, 24 W or 34 W
- 4000 K or 5000 K color temperature available
- Glare-free, clear prismatic or satine acrylic lens
- 100% to 10% dimming capability
- Anodized aluminum housing
- Spring-balanced arm with 3D head joint
- Touch panel integrated in the luminaire head for on/off and dimming
- Wall power supply (14 W) or inline power supply (24 W and 34 W)
- 100–240 VAC, 50/60 Hz
- 11' cable with US plug included
- ETL/cETL approved

### SPECIFICATIONS:

Voltage	100-240 VAC, 50/60 Hz
Lamping	LED
Controls	touch switch on head
Color Temperature	4000 K or 5000 K
Color Rendering Index (CRI)	80
Luminaire Head Material	anodized aluminum
Arm Material	aluminum
Lens Material	polycarbonate
Head Dimension	8.6", 15.7" or 22.7"
Arm Style	31" double arm
Power Consumption	14 W, 24 W or 34 W
Connection	11' cable w/ plug
Protection Rating	IP20
Certification	ETL/cETL
Mounting and accessories	See page 75



TANEO is a sophisticated LED lighting solution designed to provide premium performance for a myriad of task lighting applications. With three available light output levels, as well as options for lenses, color rendering and the type of mounting that will work best, TANEO can properly fulfill every luminance requirement. TANEO is energy-efficient, consuming 30% less energy when compared to conventional task luminaires with the same luminous power. High lighting quality and ergonomic handling make TANEO ideal for manufacturing, assembly or quality control procedures, as well as in laboratory, electronic, watchmaking, or dental applications.



## DIMENSIONAL DATA

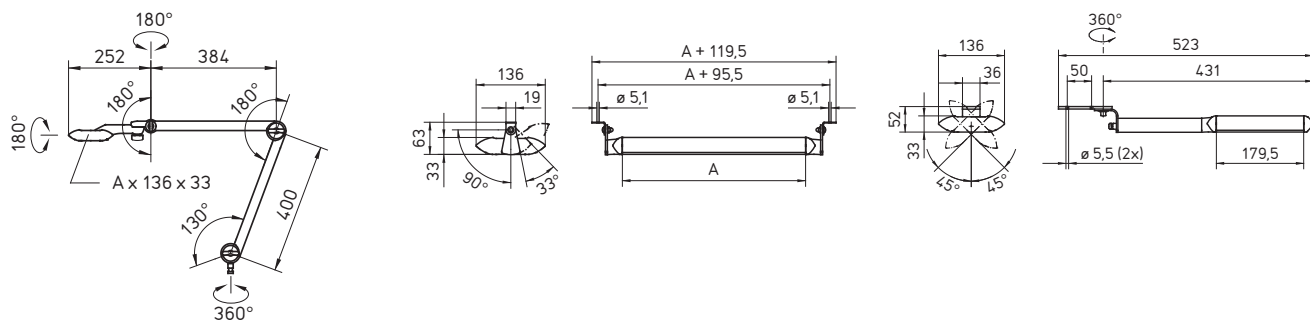

Measurements in millimeters

## ORDERING INFORMATION

Version	Wattage	Color Temp.	Lens	Dimension (A)	Lumens	Model	Part #
Double arm	14 W	4000 K	Clear prismatic	8.6" (218 mm)	650	STZL 12 R	112576000-00562055
Double arm	14 W	5000 K	Clear prismatic	8.6" (218 mm)	650	STZL 12 R	112576000-00562045
Double arm	14 W	4000 K	Satine	8.6" (218 mm)	600	STZL 12 R	112576000-00562095
Double arm	14 W	5000 K	Satine	8.6" (218 mm)	600	STZL 12 R	112576000-00562104
Double arm	24 W	4000 K	Clear prismatic	15.7" (398 mm)	1300	STZL 24 R	112577000-00562130
Double arm	24 W	5000 K	Clear prismatic	15.7" (398 mm)	1300	STZL 24 R	112577000-00562141
Double arm	24 W	4000 K	Satine	15.7" (398 mm)	1200	STZL 24 R	112577000-00562157
Double arm	24 W	5000 K	Satine	15.7" (398 mm)	1200	STZL 24 R	112577000-00562177
Double arm	34 W	4000 K	Clear prismatic	22.7" (577 mm)	1950	STZL 36 R	112578000-00562192
Double arm	34 W	5000 K	Clear prismatic	22.7" (577 mm)	1950	STZL 36 R	112578000-00562207
Double arm	34 W	4000 K	Satine	22.7" (577 mm)	1800	STZL 36 R	112578000-00562219
Double arm	34 W	5000 K	Satine	22.7" (577 mm)	1800	STZL 36 R	112578000-00562228
Mounted swivel arm	14 W	4000 K	Clear prismatic	8.6" (218 mm)	650	SARKL 12 R	112991000-00562401
Mounted swivel arm	14 W	5000 K	Clear prismatic	8.6" (218 mm)	650	SARKL 12 R	112991000-00562464
Mounted swivel arm	14 W	4000 K	Satine	8.6" (218 mm)	600	SARKL 12 R	112991000-00562476
Mounted swivel arm	14 W	5000 K	Satine	8.6" (218 mm)	600	SARKL 12 R	112991000-00562486
Fixed mount with rotation	24 W	4000 K	Clear prismatic	15.7" (398 mm)	1300	SARL 24 R	112992000-00562495
Fixed mount with rotation	24 W	5000 K	Clear prismatic	15.7" (398 mm)	1300	SARL 24 R	112992000-00562510
Fixed mount with rotation	24 W	4000 K	Satine	15.7" (398 mm)	1200	SARL 24 R	112992000-00562522
Fixed mount with rotation	24 W	5000 K	Satine	15.7" (398 mm)	1200	SARL 24 R	112992000-00562543
Fixed mount with rotation	34 W	4000 K	Clear prismatic	22.7" (577 mm)	1950	SARL 36 R	112993000-00562556
Fixed mount with rotation	34 W	5000 K	Clear prismatic	22.7" (577 mm)	1950	SARL 36 R	112993000-00562567
Fixed mount with rotation	34 W	4000 K	Satine	22.7" (577 mm)	1800	SARL 36 R	112993000-00562589
Fixed mount with rotation	34 W	5000 K	Satine	22.7" (577 mm)	1800	SARL 36 R	112993000-00562598

## Mounting Options

Item	Dimensions	Part #
Table clamp for pin mount (included)	0" x 3.5" span	19102506940
Wall bracket	3" x 3"	226108019-00610754
1/2" pin mount adapter	1.77" length	US0209022
1/2" pin mount adapter	3.75" length	US0209012

## Accessories

Item	Magnification	Size	Part #
Clip-on magnifier	3.5 diopters (1.88X)	5" diameter	190207019-00575900

# TAMETO

## WORKSTATION LIGHTING

### FEATURES:

- Various lengths for different bench widths and lighting requirements
- Up to 60% energy savings and up to 40% higher illuminance when compared to conventional CFL lamps
- LED or T5HO fluorescent lamp options with a service life of up to 50,000 hours (LED) or 24,000 hours (fluorescent)
- Fixed or suspended installation options available
- Minimal heat generation
- Integrated T-slots allow direct installation into truss type workstations
- Extremely strong aluminum housing
- Premium workmanship in accordance with Waldmann's quality standards

### SPECIFICATIONS:

Voltage	100-240 VAC
Lamping	LED or T5HO fluorescent
Controls	rocker switch
Color Temperature	4000 K
Color Rendering Index (CRI)	80
Beam Angle	80°
Luminaire Head Material	anodized aluminum
Lens Material	PMMA acrylic
Luminaire Dimension	varied lengths, 7.4" width
Mounting	T-rail brackets included
Connection	9' cable w/ NEMA 5-15 plug or plug/bushing (thru-wired)
Protection Rating	IP20
Certification	ETL/cETL
Mounting and accessories	See page 75



TAMETO is designed to offer broad, bright light output for workbenches and assembly workstations with ergonomic support. It reduces glare, eye strain and fatigue, providing a comfortable work environment for long workdays. Strong, sleek and minimalist, the TAMETO has a closed design suitable for cleanroom applications. Available in LED and T5HO fluorescent versions, the extremely long lamp life and 60% energy savings make the TAMETO the perfect complement to a busy workplace.



Shown with T-rail bracket (included)



## DIMENSIONAL DATA



TAMETO Side Mount



TAMETO Top Fixed Mount

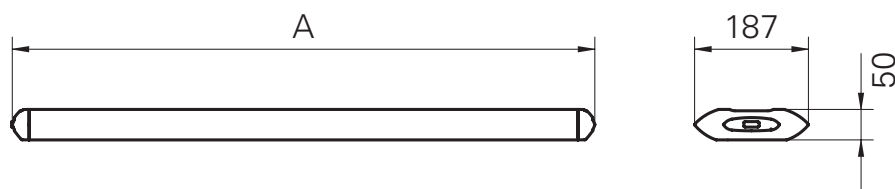

Measurements in millimeters

## ORDERING INFORMATION

Wattage	Light Source	Length (A)	Mounting	Lumens	Model	Part #
18 W	LED	17.9" (456 mm)	Side mount	1400	SAHKQ 60	112989000-00636407
18 W	LED	25.8" (656 mm)	Top fixed	1500	SAHQ 44	112971000-00636165
26 W	LED	37.6" (956 mm)	Top fixed	2400	SAHQ 66	112975000-00555619
33 W	LED	49.5" (1256 mm)	Top fixed	3200	SAHQ 88	112979000-00555677
27 W	T5HO fluorescent	25.8" (656 mm)	Top rotating	1750	SAH 124	112969000-00631173
42 W	T5HO fluorescent	37.6" (956 mm)	Top rotating	3100	SAH 139	112973000-00556029
60 W	T5HO fluorescent	49.5" (1256 mm)	Top rotating	4450	SAH 154	112977000-00556183

Mounting Options	Item	Unit	Part #
	Mounting brackets, for use with top mount versions	Sold as set	408001586-00578088

FOR DETAILED SPECIFICATIONS, PLEASE VISIT [WALDMANNLIGHTING.COM](http://WALDMANNLIGHTING.COM)

# WLA

## LED WORKSTATION LIGHT

### FEATURES:

- LED overhead workstation light
- 50,000 hours of maintenance-free operation
- Thru-wire capability for daisy-chaining
- Housing of anodized aluminum/plastic
- Premium LED materials and technology
- 5000 K color temperature for clear, bright illumination onto the work surface
- Built-in Wieland GS18/3 connector/socket
- ETL/cETL approved

### SPECIFICATIONS:

Voltage	120-240 VAC; 50/60 Hz
Lamping	LED
Color Temperature	5000 K
Color Rendering Index (CRI)	>80
Luminaire Material	anodized aluminum/plastic
Lens Material	polycarbonate prismatic lens
Dimensions	see chart
Connection	8.2' cable w/ US plug
Protection Rating	IP20
Certification	ETL/cETL
Mounting and accessories	See page 76



WLA LED, Waldmann's task light for workbenches brings superb light quality (CRI>80) and color temperature (5000 K) along with extreme energy-efficiency (50,000 hours of maintenance-free operation) to the factory workbench. The anodized aluminum housing and the polycarbonate prismatic lens protect the workings of the fixture from environmental dust or other small particles that may be present. Three lengths (35.4", 47.2" and 59") make this strong, durable work light easy to match to work space, no matter the size. In addition, all versions are designed for easy thru-wire installation.



Machine

Task & Workbench

**DIMENSIONAL DATA**



Magnification & Inspection

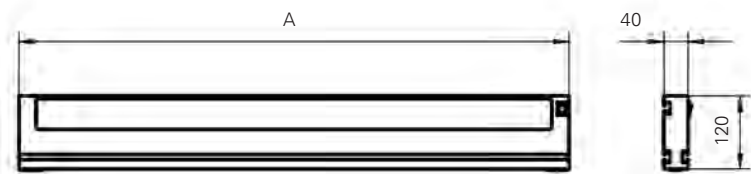

Measurements in millimeters

Facility Lighting

**ORDERING INFORMATION**

Wattage	Length (A)	Lumens	Model	Part #
37 W	35.4" (899 mm)	3000	WLA 3000/850/T	113475000-00704990
43 W	47.2" (1199 mm)	3700	WLA 3700/850/T	113476000-00704993
57 W	59" (1499 mm)	5000	WLA 5000/850/T	113477000-00704996

Mounting Options	Item	Part #
	T-Bracket set (included)	408109019-00728797
	Power cable (included)	330690010-00577358

Accessories

# ALD

## INDUSTRIAL LED TASK LIGHT

### FEATURES:

- Functional and easy-to-use tough LED task light
- On/off and dimming switch conveniently located on the head
- Ergonomically friendly for working comfortably
- Ideal for environments requiring lengthy periods of work time
- Wide area illumination and glare-free lens to combat tired eyes
- Color rendering >80, 5000K color temperature
- Perfectly balanced, anodized aluminum, adjustable double arm
- 3D head-joint enables 180 degrees turn for ease of use
- Ideal for assembly applications, inspection areas or any other industrial workstation

### SPECIFICATIONS:

Voltage	100-240 V; 50/60 Hz
Lamping	LED
Lumen Output	1250 lumens
Operation	push button
Color Temperature	5000 K
Color Rendering Index (CRI)	>80
Lens Material	Polycarbonate
Head Dimensions	14" x 3" x 0.9"
Arm Reach	31"
Power Consumption	16 W
Protection Rating	IP20
Certification	ETL/cETL, CE
Cord/Plug	10' with plug
Mounting and accessories	See page 74



The flexible ALD arm-mounted task light impresses with the latest LED technology, 3D head joint and sturdy anodized aluminum adjustable arm. ALD's conveniently placed touch panel for on/off or continuous dimming and glare-free specially designed polycarbonate lens, ensure ergonomically friendly working conditions. The ALD also features a color temperature of 5000K and CRI of Ra>80 for meeting the high-precision standards of inspection applications, assembly area activities or other shift work requiring long hours.



#### DIMENSIONAL DATA

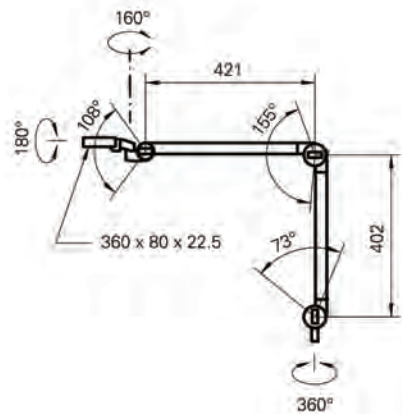

#### ORDERING INFORMATION

Wattage	Voltage	Arm Reach	Color Temp	Model	Part #
16 W	100-240 V	31"	5000 K	ALD	113686000-00753168

Mounting Options	Item	Part #
	Table Clamp for pin mount (included)	ILL00100C-00050472
	Wall Bracket	308218109
	Table Base for pin mount	190186019-00009644
	Floor stand with casters, 25" diameter	US1043019
	1/2" pin mount adapter, 1.77" length	US0209022
	1/2" pin mount adapter, 3.75" length	US0209012

# SNE

## UNIVERSAL INDUSTRIAL FLUORESCENT TASK LIGHT

### FEATURES:

- Long 19" head provides 2900 lumens of light output
- Built-in parabolic louver directs light precisely to work areas and eliminates glare
- 36" adjustable spring-loaded arm provides easy positioning
- Built-in electronic ballast for energy efficiency

### SPECIFICATIONS:

Voltage	120 VAC, 50/60 Hz
Lamping	CFL
Operation	includes switch
Color Temperature	5400 K
Color Rendering Index (CRI)	80
Lamp Cover	polycarbonate lens
Head Dimensions	19" x 4.6" x 2.8"
Arm Style	36" double-arm
Power Consumption	36 W
Connection	6' cable with NEMA 5-15 plug
Protection Rating	IP20
Certification	ETL/cETL
Mounting and accessories	See page 75



Shown with clip-on magnifier; sold separately

SNE-136 provides wide ambient light to small and mid-size work areas requiring bright illumination for precise visual tasks. It is ideal for mounting on to the workstation, bench or inspection area. SNE features a long, 19" luminaire head with a 36 W compact fluorescent lamp. The built-in parabolic micro-grid louver directs light downward onto the work area and eliminates glare for the operator. A 36" adjustable, spring-loaded arm provides easy positioning and precise orientation. The SNE workstation luminaire has a built-in electronic ballast for greater energy efficiency and long life. The multi-functional SNE-136 task light provides even illumination with maximum light output.





## DIMENSIONAL DATA

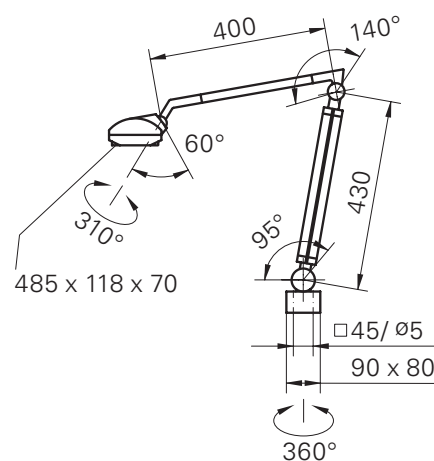

Measurements in millimeters

## ORDERING INFORMATION

Wattage	Voltage	Arm Style	Color Temp.	Louwer	Model	Part #
36 W	120 V	36" double arm	5400 K	Yes	SNE-136	138462003-00020895

Mounting Options	Item	Dimensions	Part #
	Table clamp for pin mount (included)	2.5" x 2.5"	191025069 40
	Universal base for table/wall	2.4" x 2.4"	204090019
	Table clamp (requires universal base)	2" – 5.4" span	190033019-00014950
	Wall bracket	3" x 3"	226108019-000610754
	Table base for pin mount, round	10" diameter	190186019-00009644
	1/2" pin mount adapter	1.77" length	US0209022
	1/2" pin mount adapter	3.75" length	US0209012

Accessories	Item	Magnification	Part #
	Clip-on magnifier	3 diopters (1.75X)	190182019-00078702
	Add-x lens (snaps into clip-on magnifier)	4 diopters (2X)	190080019
	Add-x lens (snaps into clip-on magnifier)	4 + 12 diopters (4X)	190080029

Replacement Lamps	Item	Color Temp	Part #
	36 W CFL	4100 K	450036M10
	36 W CFL (included)	5400 K	450036190-00041493
	36 W CFL	6000 K	450036222-00062234



## INDUSTRIAL LIGHTING | MAGNIFICATION & INSPECTION

<b>TEVISIO</b> - LED MAGNIFIER	<b>52 - 53</b>
<b>RING LED</b> - LED MAGNIFIER	<b>54 - 55</b>
<b>OMNIVUE LED</b> - STADIUM LENS MAGNIFIER	<b>56 - 57</b>
<b>MLD</b> - LED MAGNIFIER	<b>58 - 59</b>

Machine

Task &amp; Workbench

Magnification &amp; Inspection

Facility Lighting

Accessories

# TEVISIO

## LED MAGNIFIER



### FEATURES:

- 6" diameter wide-angle, scratch-resistant glass lens
- Spring-balanced arm for easy adjustments
- Available in 31" or 39" arm length versions
- Available in ESD versions
- 40% energy savings compared to fluorescents
- 50,000 hours maintenance-free LED life
- 100% to 10% dimming capability

### SPECIFICATIONS:

Voltage	100-240 VAC, 50/60 Hz
Lamping	48 x LED
Operation	touch-panel on head
Magnification	3.5 diopters or 3.5d + 8d
Color Temperature	5000 K
Color Rendering Index (CRI)	90
Luminaire Material	anodized aluminum
Lens Material	glass
Lens Dimension	6.3" diameter
Arm Reach	31" or 39"
Power Consumption	14 W
Connection	12' cable w/ US plug
Protection Rating	IP20
Certification	ETL/cETL
Mounting and accessories	See page 77



Shown with add-x magnifier sold separately



TEVISIO lives up to the high standards of the Waldmann product line. 48 premium LEDs illuminate a 6" wide-angle, distortion-free lens. Touch enabled dimming provides customization of the light output from 100% to 10%. Innovative balanced-arm technology allows for easy adjustment and precise positioning while six independent swivel joints turn the head up to 90 degrees in every direction. TEVISIO compares at 40% more efficient than conventional magnifier luminaires.

## DIMENSIONAL DATA

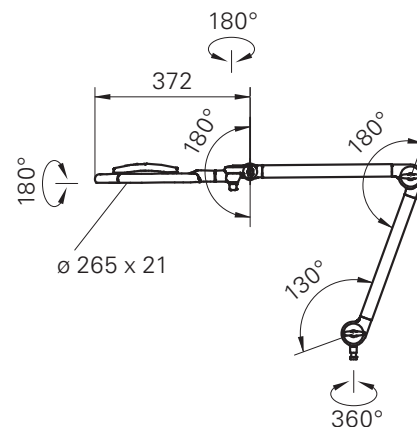

Measurements in millimeters

## ORDERING INFORMATION

Wattage	Version	Arm Reach	Magnification	Segment Switching	Lumens	Model	Part #
14 W	Standard	31" (784 mm)	3.5 diopters	No	600	RLLQ 48 R	112919000-00587335
14 W	Standard	31" (784 mm)	3.5 + 8 diopters	No	600	RLLQ 48 R	112919000-00587338
14 W	Standard	31" (784 mm)	3.5 diopters	Yes	600	RLLQ 48 2/R	112919000-00587341
14 W	Standard	31" (784 mm)	3.5 + 8 diopters	Yes	600	RLLQ 48 2/R	112919000-00587344
14 W	Max	39" (984 mm)	3.5 diopters	No	600	RLLQ 48 R	112918000-00587322
14 W	Max	39" (984 mm)	3.5 + 8 diopters	No	600	RLLQ 48 R	112918000-00587326
14 W	Max	39" (984 mm)	3.5 diopters	Yes	600	RLLQ 48 2/R	112918000-00587329
14 W	Max	39" (984 mm)	3.5 + 8 diopters	Yes	600	RLLQ 48 2/R	112918000-00587332
14 W	ESD	31" (784 mm)	3.5 diopters	No	600	RLLQ 48 R	113016000-00595384
14 W	ESD	39" (984 mm)	3.5 diopters	No	600	RLLQ 48 R	113015000-00595377

Mounting Options	Item	Dimensions	Part #
	Table clamp for pin mount (included)	0" - 3.5" span	19102506940
	Wall bracket for pin mount	3" x 3"	226108019-00610754
	Table clamp, ESD safe	0" - 3" span	190100029-00089021
	1/2" pin mount adapter	1.77" length	US0209022
	1/2" pin mount adapter	3.75" length	US0209012

Accessories	Item	Features	Part #
	Add-x magnifier	3.5 diopters (1.88X)	190208019-00575924
	Plug-in converter (included)	100-240 VAC w/quick disconnect	309414070-00555523

# RING LED

## LED MAGNIFIER

### FEATURES:

- 6 diopter optical-grade lens
- 5 inches in diameter
- 63 high-output LEDs
- 50,000 hours maintenance-free LED life
- Touch-switch for on/off operation
- Universal base with C-clamp mounting (included)
- Plug-in transformer for 100-240 VAC
- Ideal for assembly and QC inspection
- Wide light distribution
- Industrial-grade gooseneck arm is strong, even after 20,000 movements

### SPECIFICATIONS:

Voltage	100-240 VAC, 50/60 Hz
Lamping	LED
Operation	easy touch switch
Magnification	6 diopters
Color Temperature	4000 K
Color Rendering Index (CRI)	80
Luminaire Material	anodized aluminum arm
Lens Material	hard-coated acrylic
Lens Dimension	2.8" diameter
Arm Style	15.7" gooseneck
Power Consumption	6 W
Weight	2.2 lbs
Connection	7.5' cable w/ NEMA 1-15 plug
Protection Rating	IP20
Certification	ETL/cETL
Mounting and accessories	See page 77



RING LED is the lighting solution for the precise examination of parts for a number of fields of application – from mechanical engineering to research and development. This workhorse of a light is all business. The sleek design is minimal and fits easily into any workspace. The luminaire head is less than ½" thick and is 5" in diameter. The specially coated, distortion-free Eschenbach magnifier lens reaches 2.8" in diameter and offers 6 distortion-free diopters. Using innovative LEDs provides critical added value compared to conventional fluorescents: four times more light per watt, considerably lowering energy consumption. These LEDs offer a minimum of 50,000 hours of operating life at 100% brightness level.



#### DIMENSIONAL DATA



With adjustable clamp



With universal mounting base

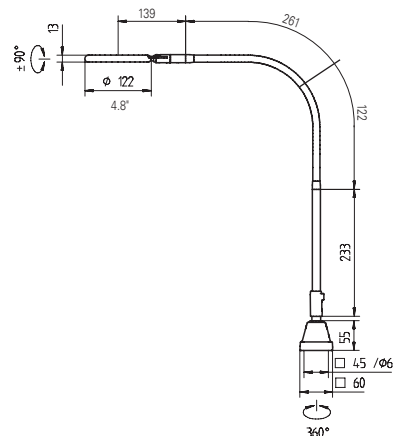

Measurements in millimeters

#### ORDERING INFORMATION

Version	Wattage	Magnification	Model	Part #
With universal base	6 W	6 diopters	RLLQ 63	113142000-00618824
With adjustable clamp	6 W	6 diopters	RLLQ 63	113142M10

Mounting Options	Item	Dimensions	Part #
	Universal base for table/wall (included - see above)	2.4" x 2.4"	204090019
	Adjustable table clamp (included - see above)	0" - 2.75" span	D14228000
	Wall bracket for universal base	2.4" x 2.8"	300213018-00025178
	Magnetic base for universal base	3.3" diameter	190057019-00015056
	Table base for pin mount, round	10" diameter	190186019 -00009644
	1/2" pin mount adapter	1.77" length	US0209022
	1/2" pin mount adapter	3.75" length	US0209012

# OMNIVUE LED

## STADIUM LENS MAGNIFIER

### FEATURES:

- 3 diopter optical glass lens
- Stadium lens offers wide viewing angles
- Magnifier tilts independently of light source for precise positioning
- Standard model offers a 35-inch reach
- OmnivueMax extends to 43 inches
- Plug-in 120 VAC operation
- C-clamp provides easy arm installation
- ESD models available
- 50,000 hours maintenance-free LED life

### SPECIFICATIONS:

Voltage	100-240 VAC, 50/60 Hz
Light source	LED
Operation	multi-level switching
Magnification	3 diopters
Color Temperature	4000 K
Lumens	1500
Lens Material	optical-grade acrylic
Lens Dimension	4.25" x 6.5"
Arm Reach	35" or 43"
Power Consumption	12 W
Connection	10' cable w/ NEMA 5-15 plug or NEMA 1-15 plug w/external transformer
Protection Rating	IP20
Certification	ETL/cETL
Mounting and accessories	See page 76



OMNIVUE LED features a distinctive, fully rotational 3-diopter magnifier lens for precise positioning and wide area magnification. Two high-quality rocker switches, built into the head, provide on/off switching as well as two light output settings. OMNIVUE LED's fully pivoting, large stadium lens provides outstanding clarity and sharpness. By positioning the magnifier independently of the light source, excellent visual contrast can be achieved, allowing for precise inspection. The C-clamp universal base included with the OMNIVUE LEDs designed for industrial applications and can be permanently installed or used as a portable table clamp.





### DIMENSIONAL DATA



OMNIVUE LED



OMNIVUE LED ESD

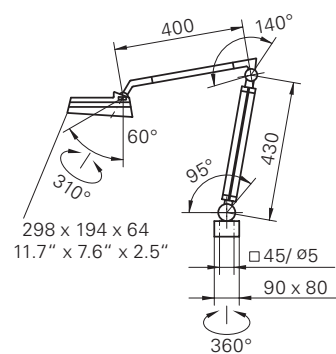

Measurements in millimeters

### ORDERING INFORMATION

Wattage	Arm Reach	Magnification	Connection/Plug	Color Temp.	Model	Part #
13W	35" reach	3 diopters (1.75X)	NEMA 1-15 plug w/external transformer	4000 K	OMNIVUE	113178000-00672403
13W	43" reach	3 diopters (1.75X)	NEMA 1-15 plug w/external transformer	4000 K	OMNIVUEMAX	113178000-00689812
12W	35" reach	3 diopters (1.75X)	NEMA 5-15 plug	4000 K	OMNIVUE	113460000-00726444
12W	43" reach	3 diopters (1.75X)	NEMA 5-15 plug	4000 K	OMNIVUEMAX	113460000-00726450
12W	35" reach	3 diopters (1.75X)	NEMA 5-15 plug	4000 K	OMNIVUE ESD	113459000-00726434
12W	43" reach	3 diopters (1.75X)	NEMA 5-15 plug	4000 K	OMNIVUEMAX ESD	113459000-00726437

Mounting Options	Item	Dimensions	Part #
	Table clamp (included)	0 - 3.5" span	19102506940
	ESD table clamp (included with ESD model)	0" - 2.6" span	191025069E2
	Wall mount, black	3.5" x 2.5" x 2.5"	308218109
	Floor stand with casters	25" diameter	US1043019
	1/2" pin mount adapter	1.77" length	US0209022
	1/2" pin mount adapter	3.75" length	US0209012

Accessories	Item	Magnification	Part #
	Add-x lens	4 diopters (2X)	190080019
	Add-x lens	4d + 12d (2x + 4X)	190080029
	Add-x ESD lens	4 diopters (2X)	190080049-00061280

# MLD

## LED MAGNIFIER

### FEATURES:

- LED technology
- 3.5 diopter magnification
- 6.3-inch diameter magnifying lens made from strong PMMA acrylic
- Ergonomic design with 2D head joint
- Color Rendering Index (CRI) >80
- 5000 K color temperature
- Continuously dimmable 100% to 10%
- Strong anodized aluminum housing
- Includes table clamp (0 – 2.7 inches)
- ETL/cETL approved

### SPECIFICATIONS:

Voltage	100-240 V; 50/60 Hz
Lamping	LED
Color Temperature	5000 K
Color Rendering Index (CRI)	>80
Double Arm Material	anodized aluminum
Head Material	durable, lightweight polymer
Lens Material	hard-coated polycarbonate
Lens Dimension	6.3" diameter
Connection	10' cable with NEMA 1-15 plug
Protection Rating	IP20
Certification	ETL/cETL
Accessories	See page 76



A perfect combination of optimal 3.5 diopter magnification and high light quality – the MLD magnifying luminaire can be used wherever a closer look is needed. The 2D head joint along with a wide field of vision allow for adjustability with comfort and ease. The 6.3-inch distortion-free lens and premium LED light offer clear, glare-free vision at the work surface. In addition, the dimming functionality makes this magnifying luminaire an indispensable tool for many industrial applications where intricate work is performed.

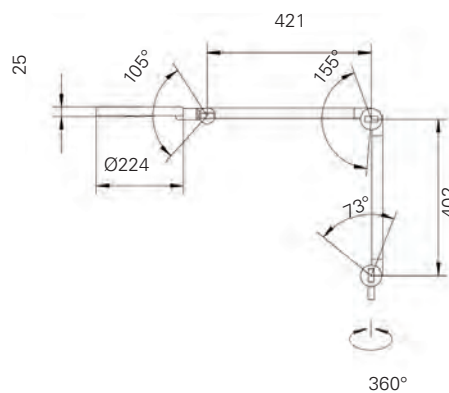

Measurements in millimeters

MOUNTING OPTIONS



Table Clamp (included)



Wall Bracket



Table Base



Rolling Floor Stand

ORDERING INFORMATION

Wattage	Arm Reach	Magnification	Color Temp	Part #
12 W	31"	3.5 diopters	5000 K	113525000-00698859
Mounting Options	Item	Dimensions	Part #	
	Table clamp (included)	0" – 2.75" span	D14228000	
	Table base for pin mount	10" diameter	190186019-00009644	
	Wall mount, black	3.5" x 2.5" x 2.5"	308218109	
	Rolling Floor Stand	25" diameter	US1043019	

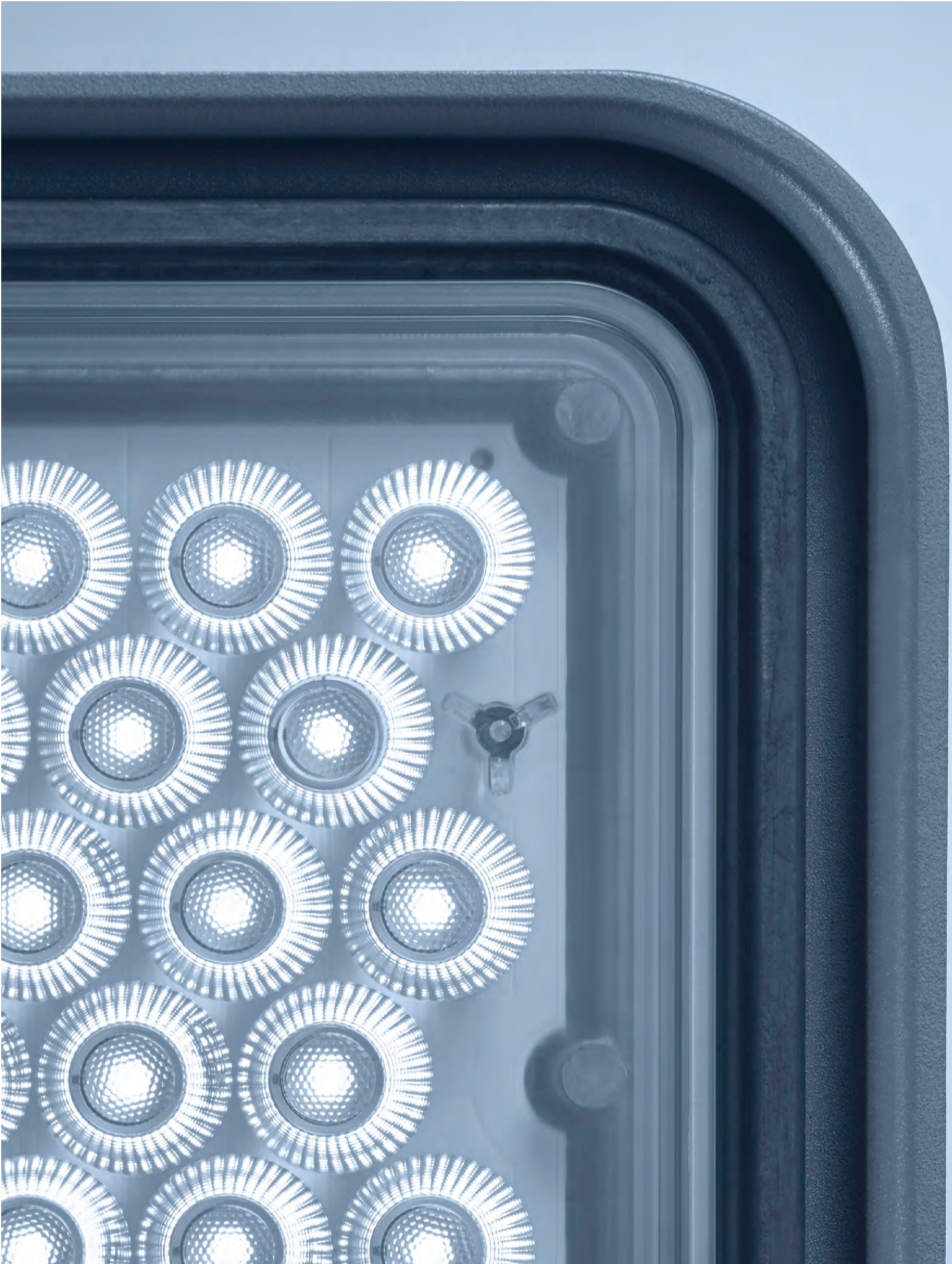

## INDUSTRIAL LIGHTING | FACILITY LIGHTING

**ACANEO** - LED HIGH BAY

**62 - 63**

**VYPOR** - INDOOR/OUTDOOR VAPOR TIGHT LIGHT

**64 - 65**

Machine

Task & Workbench

Magnification & Inspection

Facility Lighting

Accessories

# ACANEO

## LED HIGH BAY/LOW BAY

### FEATURES:

- Modular mounting system easy to install
- Sealed IP65 closed design protects from oils, coolants and other vapors
- Advanced LED technology with up to 60,000 hours of maintenance-free LED operation (L80>)
- Three lumen options: 14,000, 20,000 and 30,000
- Up to 158°F/70°C ambient temperature for EXTREME model; 140°F/60°C for Standard model
- Available in narrow or wide light distribution
- Extremely robust die-cast aluminum housing
- 4000 K or 5000 K color temperature available
- Patented lenses ensure precise light deflection at UGR<20
- Dynamic thermal management system protects fixture and surrounding area from overheating
- Various mounting options available
- UL1598, UL8750, DLC, TUV

### SPECIFICATIONS:

Voltage	120-277 VAC
Lamping	LED
Controls	On/off or 0-10 V dimming
Color Temperatures	4000 K or 5000 K
Color Rendering Index (CRI)	>80
Material	Powder-coated aluminum
Power Consumption	100 W, 160 W, 230 W
Connection	6.5' cable
Protection Rating	IP65
Certification	UL1598, UL8750, DLC, TUV
Mounting and Accessories	See page 77

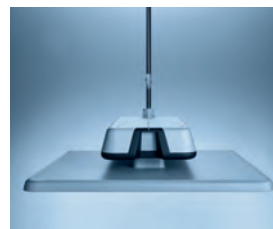

ACANEO is the newly designed modular lighting system for illuminating large warehouse and facility spaces with ceilings of up to 100 feet. Quick, uncomplicated installation and state-of-the-art LED technology make this an easy system to set up while a variety of wattage, beam and light output options allow for customization of the project. The standard model is proficient in areas where temperatures reach up to 140° F, and ACANEO EXTREME can reach temperatures up to 158° F. Thermal heat management is built in, pulling heat up and away from the light source to prevent overheating of the work area and fixture. 60,000 (L80B10) hours of maintenance-free service hours and high-quality LED operation result in significant savings in both energy efficiency and facility costs.



## DIMENSIONAL DATA

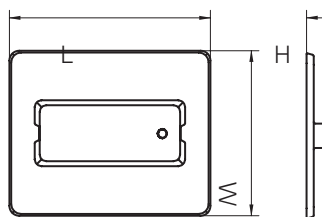

LUMENS	L	W	H
14000	19"	16"	4.6"
20000	19"	16"	4.6"
30000	23"	19"	4.6"
15400	19"	16"	4.6"
25100	23"	19"	4.6"

## ORDERING INFORMATION

Wattage	Lumens	Operation	Beam Angle	Color temp.	Max Ambient Temp	Model	Part #
100 W	14000	On/off	85°	5000 K*	140°F/60°C	HIAL 14000/850/W/EA‡	113431000-00693029
100 W	14000	Dimmable 1-10 V	85°	5000 K*	140°F/60°C	HIAL 14000/850/W/1-10 V‡	113389000-00692903
160 W	20000	On/off	55°	5000 K*	140°F/60°C	HIAL 20000/850/N/EA‡	113347000-00692720
160 W	20000	Dimmable 1-10 V	55°	5000 K*	140°F/60°C	HIAL 20000/850/N/1-10 V‡	113231000-00682473
160 W	20000	On/off	85°	5000 K*	140°F/60°C	HIAL 20000/850/W/EA‡	113437000-00693051
160 W	20000	Dimmable 1-10 V	85°	5000 K*	140°F/60°C	HIAL 20000/850/W/1-10 V‡	113398000-00692931
230 W	30000	On/off	55°	5000 K*	122°F/50°C	HIAL 30000/850/N/EA‡	113353000-00692743
230 W	30000	Dimmable 1-10 V	55°	5000 K*	122°F/50°C	HIAL 30000/850/N/1-10 V‡	113240000-00682500
230 W	30000	On/off	85°	5000 K*	122°F/50°C	HIAL 30000/850/W/EA‡	113443000-00693069
230 W	30000	Dimmable 1-10 V	85°	5000 K*	122°F/50°C	HIAL 30000/850/W/1-10 V‡	113407000-00692959
116 W	15400	Dimmable 1-10 V	55°	5000 K*	158°F/70°C	HIAL 20000/850/N/1-10V	113231000 – EXTREME
116 W	15400	Dimmable 1-10 V	85°	5000 K*	158°F/70°C	HIAL2000/850/W/1-10V	113398000 – EXTREME
190 W	25100	Dimmable 1-10 V	55°	5000 K*	140°F/60°C	HIAL-3000/850/N/1-10V	113240000 – EXTREME
190 W	25100	Dimmable 1-10 V	85°	5000 K*	140°F/60°C	HIAL-3000/850/W/1-10V	113407000 – EXTREME

Mounting Options	Item	Part #
	Ceiling bracket - fixed	337818010-00695171
	Ceiling bracket - adjustable	337818020-00695174
	Wall bracket	337763010-00682509
	One-point suspension bracket kit with cables	226234019



‡Products are DesignLights Consortium (DLC) qualified

\*Also available in 4000 K models

# VYPOR LED

## INDOOR/OUTDOOR VAPOR TIGHT LIGHT

### FEATURES:

- Vandal-resistant, air and vapor tight seal
- Suitable for wet and spray-down environments
- 114,000 hours of maintenance-free operation
- UV stabilized linear prismatic lens
- Strong polycarbonate housing
- Wide, quick-release stainless steel latches and mounting bracket system
- Lever-release terminal block for easy wiring
- Premium LED materials and technology
- 5000 K color temperature
- ETL/cETL, DLC, NSF/ANSI12 approved

### SPECIFICATIONS:

Voltage	120-277 VAC; 50/60 Hz
Lamping	LED
Color Temperature	5000 K
Color Rendering Index (CRI)	>80
Luminaire Material	polycarbonate
Lens Material	polycarbonate prismatic lens
Dimensions	4' or 8' length
Temperature Range	-22°F to 104°F (-30°C to 40°C)
Connection	hardwired
Protection Rating	IP66
Certification	ETL/cETL, DLC, NSF/ANSI 2
Mounting Accessories	included



Waldmann's latest, VYPOR LED lights the large, hard-to-light areas such as parking garages, industrial buildings, tunnels, sport arenas, etc. with ease. Robust materials and a smart design make VYPOR vandal-resistant and effective even in dusty, dirty and wet locations (IP66 Protection Rating). Featuring two LED light strips embedded in the aluminum gear tray, a high transmission diffuser has been added to the LED channels, enhancing light distribution as well as eliminating any possible hot spots. VYPOR was designed collaboratively with a team of electrical distributors in an effort to surpass the quality of other products in the industrial arena and to meet the demands of jobs requiring the strength, ease of installation and maintenance-free capabilities so beneficial for these large areas.



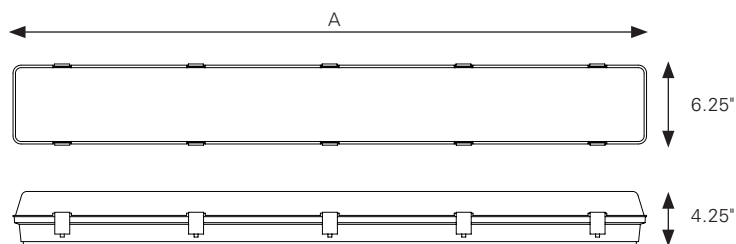
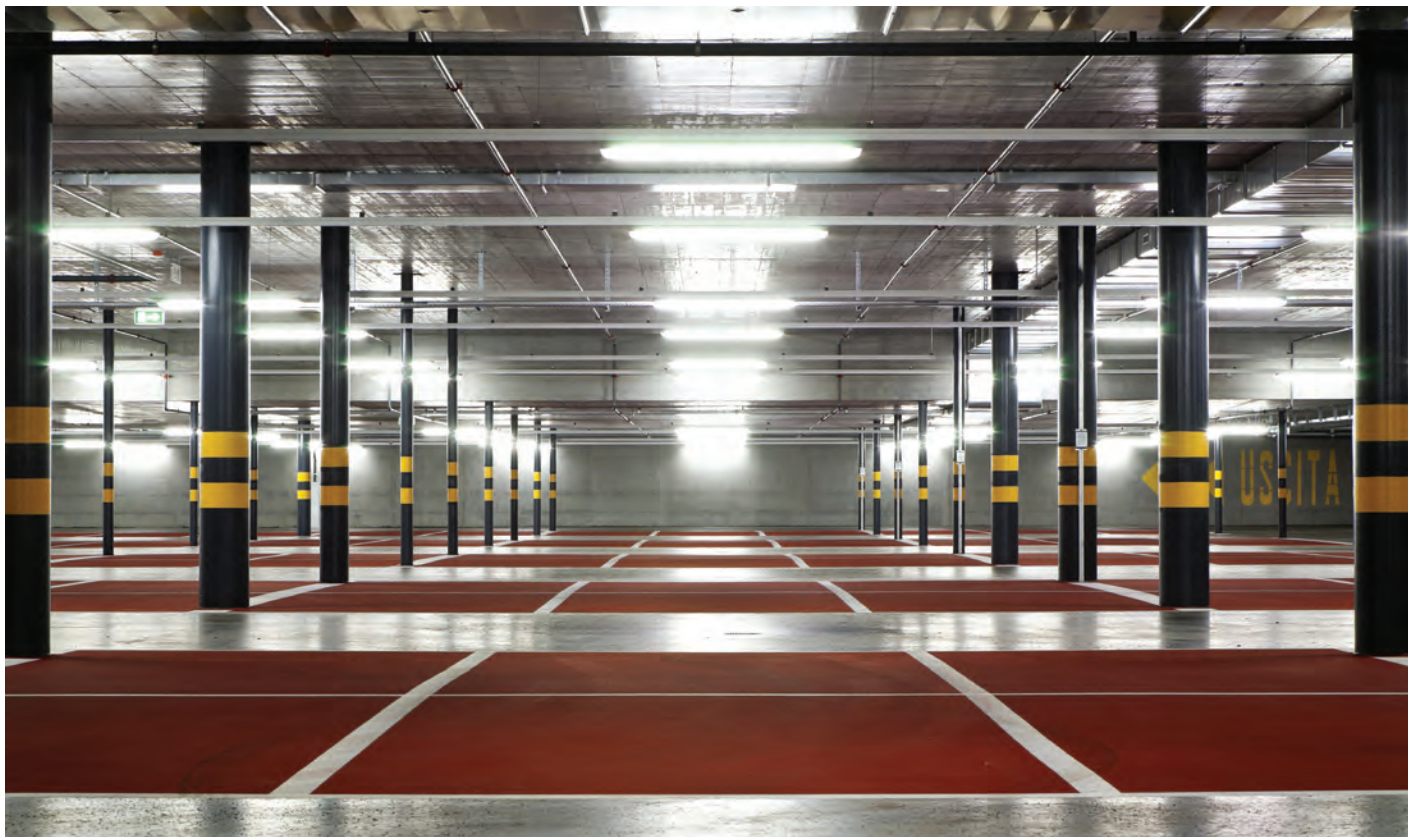

#### ORDERING INFORMATION

Wattage	Length (A)	Lumens	Part #
48 W	50" (1240 mm)	4545	VPR448000
96 W	102" (2597 mm)	9332	VPR896000



## ACCESSORIES | MACHINE

<b>ABL LED</b>	<b>68</b>
<b>AWD</b>	<b>68</b>
<b>FLAT LED</b>	<b>68</b>
<b>HEAD LED</b>	<b>68</b>
<b>LUMATRIS</b>	<b>69</b>
<b>MACH LED PLUS.seventy</b>	<b>70</b>
<b>MACH LED PLUS.forty</b>	<b>70</b>
<b>MACH LED PRO</b>	<b>71</b>
<b>ONE LED</b>	<b>71</b>
<b>RAPTOR</b>	<b>71</b>
<b>RL70LE</b>	<b>72</b>
<b>RL70</b>	<b>73</b>
<b>ROCIA.FOCUS</b>	<b>74</b>
<b>ROCIA.PLANAR</b>	<b>74</b>
<b>SLIM LED</b>	<b>74</b>

## ACCESSORIES | TASK & WORKBENCH

<b>ALD</b>	<b>74</b>
<b>SNE</b>	<b>75</b>
<b>TAMETO</b>	<b>75</b>
<b>TANEO</b>	<b>75</b>
<b>WLA</b>	<b>76</b>









## ACCESSORIES | MAGNIFICATION & INSPECTION

<b>MLD</b>	<b>76</b>
<b>OMNIVUE LED</b>	<b>76</b>
<b>RING LED</b>	<b>77</b>
<b>TEVISIO</b>	<b>77</b>

## ACCESSORIES | FACILITY

<b>ACANEO</b>	<b>77</b>
---------------	-----------

## ABL LED ACCESSORIES

Item	Description	Part #
	MOUNTING OPTION: Universal base for table/wall (included)	204090019
	MOUNTING OPTION: Table clamp, 0" - 2.75" span	190007019-00014904
	MOUNTING OPTION: Table clamp, 2.5" - 5.4" span	190033019-00014950
	MOUNTING OPTION: Wall bracket, standard	300213018-00025178
	MOUNTING OPTION: Magnetic base, 3.3" diameter	190057019-00015056
	MOUNTING OPTION: Table base, rectangular, 10" x 6.7" x 1"	190036109-00058238
	OPERATING DEVICE, Type A, 19.2 V-28.8 VDC, 700mA	209582019-00048793
	OPERATING DEVICE, VLM, 95 V-240 VAC, 700mA	209585019-00045202



## AWD ACCESSORY

Item	Description	Part #
	MOUNTING OPTION: Wall bracket, Black, 3.1" x 3.3"	191092019-00086727















## FLAT LED ACCESSORIES

Item	Description	Part #
	MOUNTING OPTION: Swivel bracket	203081019-00019478
	OPERATING DEVICE: Max. Wattage = 20 W to run at 100-277 VAC, 50/60 Hz	209585029
	OPERATING DEVICE: Max. Wattage = 50 W to run at 120 VAC, 50/60 Hz	209585030
	OPERATING DEVICE: Max. Wattage = 96 W to run at 120-277 VAC, 50/60 Hz	209585032

## HEAD LED ACCESSORIES

Item	Description	Part #
	OPERATING DEVICE: Max. Wattage = 20 W to run at 100-277 VAC, 50/60 Hz	209585029
	ACCESSORY: M12 connector plug, straight (included)	330603020-00002947

## LUMATRIS ACCESSORIES

Item	Description	Part #
	MOUNTING OPTION: Flush mounting frame, 9.7" x 3.7"	408001016-00595619
	MOUNTING OPTION: Flush mounting frame, 16.5" x 3.7"	408001017-00595613
	MOUNTING OPTION: Flush mounting frame , 23.5" x 3.7"	408001018-00595610
	MOUNTING OPTION: Flush mounting frame , 30.3" x 3.7"	408001019-00595616
	MOUNTING OPTION: Flush mounting frame, 16.5" x 6.7"	408001037-00518121
	MOUNTING OPTION: Flush mounting frame, 30.3" x 6.7"	408001034-00514265
	MOUNTING OPTION: Surface mounting bracket, set, for 3.7" length	408001015-00595587
	MOUNTING OPTION: Surface mounting bracket, set, for 6.7" length	408001035-00514268
	MOUNTING OPTION: 45° Rotating surface bracket, 3.7" width, set	408001016
	MOUNTING OPTION: Pivoting arm mount	408001033-00514262
	CONNECTOR: M12 connector w/ 16' cable assembly (included), straight, A-coded, 24 VDC	US0009101
	CONNECTOR: M12 connector w/ 16' cable assembly (included), angled, A-coded, 24 VDC	US0009011
	OPERATING DEVICE: Max. Wattage = 20 W to run at 100-277 VAC, 50/60 Hz	209585029
	OPERATING DEVICE: Max. Wattage = 50 W to run at 120 VAC, 50/60 Hz	209585030
	OPERATING DEVICE: Max. Wattage = 96 W to run at 120-277 VAC, 50/60 Hz	209585032

Machine











Task &amp; Workbench

Magnification &amp; Inspection







Facility Lighting

Accessories



**MACH LED PLUS.seventy ACCESSORIES**

Item	Description	Part #
	MOUNTING OPTION: End bracket set, adjustable, +/- 65°	408001876-00582065
	MOUNTING OPTION: Clip bracket, adjustable, +/- 30° (sold separately)	408001878-00585535
	MOUNTING OPTION: Protective cap set (not for use with end brackets)	408001875-00582072
	OPERATING DEVICE: Max. Wattage = 20 W to run at 100-277 VAC, 50/60 Hz	209585029
	OPERATING DEVICE: Max. Wattage = 50 W to run at 120 VAC, 50/60 Hz	209585030
	OPERATING DEVICE: Max. Wattage = 96 W to run at 120-277 VAC, 50/60 Hz	209585032
	CONNECTOR: M12 connector w/ 16' cable assembly (included), straight, A-coded, 18-30 VDC	US0009001
	CONNECTOR: M12 connector w/ 16' cable assembly (included), straight, S-coded, 100-240 VAC	US0009201
	CONNECTOR: M12 connector w/ 16' cable assembly (included), angled, A-coded, 18-30 VDC	US0009011
	CONNECTOR: M12 connector w/ 16' cable assembly (included), angled, S-coded, 100-240 VAC	US0009211



**MACH LED PLUS.forty ACCESSORIES**

Item	Description	Part #
	MOUNTING OPTION: End bracket set, adjustable, +/- 90°	408001403-00671626
	MOUNTING OPTION: Clip bracket, adjustable, +/- 20° (sold separately)	408001402-00671623
	OPERATING DEVICE: Max. Wattage = 20 W to run at 100-277 VAC, 50/60 Hz	209585029
	OPERATING DEVICE: Max. Wattage = 50 W to run at 120 VAC, 50/60 Hz	209585030
	OPERATING DEVICE: Max. Wattage = 96 W to run at 120-277 VAC, 50/60 Hz	209585032
	CONNECTOR: M12 connector w// 16' cable assembly (included), straight, A-coded, 24 VDC	US0009001
	CONNECTOR: M12 connector w/ 16' cable assembly (included), angled, A-coded, 24 VDC	US0009011

**MACH LED PRO ACCESSORIES**

Item	Description	Part #
	OPERATING DEVICE: Max. Wattage = 20 W to run at 100-277 VAC, 50/60 Hz	209585029
	OPERATING DEVICE: Max. Wattage = 50 W to run at 120 VAC, 50/60 Hz	209585030
	OPERATING DEVICE: Max. Wattage = 96 W to run at 120-277 VAC, 50/60 Hz	209585032















**ONE LED ACCESSORIES**

Item	Description	Part #
	OPERATING DEVICE: Max. Wattage = 20 W to run at 100-277 VAC, 50/60 Hz	209585029
	OPERATING DEVICE: Max. Wattage = 50 W to run at 120 VAC, 50/60 Hz	209585030
	OPERATING DEVICE: Max. Wattage = 96 W to run at 120-277 VAC, 50/60 Hz	209585032

**RAPTOR ACCESSORIES**















Item	Description	Part #
	MOUNTING OPTION: Table clamp, 0" - 2.75" span	190007019-00014904
	MOUNTING OPTION: Table clamp, 2.5" - 5.4" span	190033019-00014950
	MOUNTING OPTION: Wall bracket for universal base, 2.4" x 2.8"	300213018-00025178
	MOUNTING OPTION: Magnetic base, 3.3" diameter	190057019-00015056
	OPERATING DEVICE: Max. Wattage = 20 W to run at 100-277 VAC, 50-60 Hz	209585029

## RL70LE ACCESSORIES

Item	Description	Part #
	MOUNTING OPTION: Bracket, straight, galvanized steel, neoprene	190015019-00014930
	MOUNTING OPTION: Bracket, long-L, galvanized steel, neoprene	SK1021019-00010286
	MOUNTING OPTION: Bracket, short-L, galvanized steel, neoprene	190015995
	MOUNTING OPTION: Bracket, straight, galvanized steel, profiled rubber	190015719-00085498
	MOUNTING OPTION: Bracket, long-L, galvanized steel, profiled rubber	SK1021719-00085499
	MOUNTING OPTION: Bracket, short-L, galvanized steel, profiled rubber	SK0995719-00085652
	MOUNTING OPTION: Bracket, straight, stainless steel, neoprene	190180019-00092731
	MOUNTING OPTION: Bracket, long-L, stainless steel, neoprene	190183019-00093961
	MOUNTING OPTION: Bracket, short-L, stainless steel, neoprene	190181019-00092728
	MOUNTING OPTION: Bracket, straight, stainless steel, profiled rubber	190180719-00092730
	MOUNTING OPTION: Bracket, long-L, stainless steel, profiled rubber	190169719-00089351
	MOUNTING OPTION: Bracket, short-L, stainless steel, profiled rubber	190181719-00092729
	MOUNTING OPTION: End caps (set of two), black plastic	US0165012
	MOUNTING BRACKET, Strap, Galv. Steel, Each	190027019-00057337
	OPERATING DEVICE: Max. Wattage = 20 W to run at 100-277 VAC, 50/60 Hz	209585029
	OPERATING DEVICE: Max. Wattage = 50 W to run at 120 VAC, 50/60 Hz	209585030
	OPERATING DEVICE: Max. Wattage = 96 W to run at 120-277 VAC, 50/60 Hz	209585032



## RL70 ACCESSORIES

Item	Description	Part #
	MOUNTING OPTION: Bracket, straight, galvanized steel, neoprene	190015019-00014930
	MOUNTING OPTION: Bracket, long-L, galvanized steel, neoprene	SK1021019-00010286
	MOUNTING OPTION: Bracket, short-L, galvanized steel, neoprene	190015995
	MOUNTING OPTION: Bracket, straight, galvanized steel, profiled rubber	190015719-00085498
	MOUNTING OPTION: Bracket, long-L, galvanized steel, profiled rubber	SK1021719-00085499
	MOUNTING OPTION: Bracket, short-L, galvanized steel, profiled rubber	SK0995719-00085652
	MOUNTING OPTION: Bracket, straight, stainless steel, neoprene	190180019-00092731
	MOUNTING OPTION: Bracket, long-L, stainless steel, neoprene	190183019-00093961
	MOUNTING OPTION: Bracket, short-L, stainless steel, neoprene	190181019-00092728
	MOUNTING OPTION: Bracket, straight, stainless steel, profiled rubber	190180719-00092730
	MOUNTING OPTION: Bracket, long-L, stainless steel, profiled rubber	190169719-00089351
	MOUNTING OPTION: Bracket, short-L, stainless steel, profiled rubber	190181719-00092729
	MOUNTING OPTION: End caps (set of two), black plastic	US0165012
	OPERATING DEVICE: Remote ballast, T5 LFL, 120-277 VAC; 50/60 Hz	309361050-00092219
	OPERATING DEVICE: Remote ballast, T5 CFL, 120-277 VAC; 50/60 Hz	309439010-00093716
	OPERATING DEVICE: Remote ballast, T8 LFL, 120-277 VAC; 50/60 Hz	309368010

Machine





Task &amp; Workbench

Magnification &amp; Inspection

Facility Lighting

Accessories



## ROCIA.focus ACCESSORIES

Item	Description	Part #
	MOUNTING OPTION: Table clamp, 0" - 2.75" span	190007019-00014904
	MOUNTING OPTION: Table clamp, 2.5" - 5.4" span	190033019-00014950
	MOUNTING OPTION: Wall bracket for universal base, 2.4" x 2.8"	300213018-00025178
	MOUNTING OPTION: Magnetic base, 3.3" diameter	190057019-00015056
	OPERATING DEVICE: Max. Wattage = 20 W to run at 100-277 VAC, 50-60 Hz	209585029





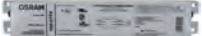

## ROCIA.planar ACCESSORIES

Item	Description	Part #
	MOUNTING OPTION: Table clamp, 0" - 2.75" span	190007019-00014904
	MOUNTING OPTION: Table clamp, 2.5" - 5.4" span	190033019-00014950
	MOUNTING OPTION: Wall bracket for universal base, 2.4" x 2.8"	300213018-00025178
	OPERATING DEVICE: Max. Wattage = 20 W to run at 100-277 VAC, 50-60 Hz	209585029











## SLIM LED ACCESSORIES

Item	Description	Part #
	OPERATING DEVICE: Max. Wattage = 20 W to run at 100-277 VAC, 50-60 Hz	209585029
	OPERATING DEVICE: Max. Wattage = 50 W to run at 120 VAC, 50/60 Hz	209585030
	OPERATING DEVICE: Max. Wattage = 96 W to run at 120-277 VAC, 50/60 Hz	209585032

## ALD ACCESSORIES

Item	Description	Part #
	MOUNTING OPTION:	ILL00100C-00050472
	MOUNTING OPTION: Wall Mount, black 3.5" x 2.5" x 2.5"	308218109
	MOUNTING OPTION: Table base for pin mount, 10" diameter	190186019-00009644
	MOUNTING OPTION: Floor stand with casters, 25" diameter	US1043019
	MOUNTING OPTION: 1/2" pin mount adapter, 1.77" length	US0209022
	MOUNTING OPTION: 1/2" pin mount adapter, 3.75" length	US0209012





**SNE ACCESSORIES**

Item	Description	Part #
	MOUNTING OPTION: Table clamp with pin mount, 0" - 3.5" span	19102506940
	MOUNTING OPTION: Universal base for table/wall, 2.4" x 2.4"	204090019
	MOUNTING OPTION: Table clamp, requires universal base, 2" - 5.4" span	190033019-00014950
	MOUNTING OPTION: Wall bracket, 3" x 3"	226108019-00610754
	MOUNTING OPTION: Table base for pin mount, 10" diameter	190186019-00009644
	MOUNTING OPTION: 1/2" pin mount adapter, 1.77" length	US0209022
	MOUNTING OPTION: 1/2" pin mount adapter, 3.75" length	US0209012
	ACCESSORY: Clip-on magnifier, 3 diopter (1.75X)	190182019-00078702
	ACCESSORY: Add-x lens (snaps into clip-on magnifier), 4 diopter (2X)	190080019
	ACCESSORY: Add-x lens (snaps into clip-on magnifier), 4 + 12 diopter (2X)	190080029

**TAMETO ACCESSORIES**

Item	Description	Part #
	MOUNTING OPTION: Mounting brackets, for use with top rotating versions	408001586-00578088



**TANEO ACCESSORIES**

Item	Description	Part #
	MOUNTING OPTION: Wall bracket, heavy duty	226108019-00610754
	MOUNTING OPTION: Table clamp with pin mount, 0" - 3.5" span (included)	19102506940
	MOUNTING OPTION: 1/2" pin mount adapter, 1.77" length	US0209022
	MOUNTING OPTION: 1/2" pin mount adapter, 3.75" length	US0209012
	ACCESSORY: Magnifier Add-x lens, 3.5 diopter	190207019-00575900









## WLA ACCESSORIES

Item	Description	Part #
	MOUNTING OPTION: T-Bracket set	408109019-00728797







## MLD ACCESSORIES

Item	Description	Part #
	MOUNTING OPTION: Table clamp (included) 0" – 2.75" span	D14228000
	MOUNTING OPTION: Table base for pin mount 10" diameter	190186019-00009644
	MOUNTING OPTION: Wall Mount, black 3.5" x 2.5" x 2.5"	308218109







## OMNIVUE LED ACCESSORIES

Item	Description	Part #
	MOUNTING OPTION: Table clamp (included), 0 - 3.5" span	19102506940
	MOUNTING OPTION: ESD table clamp (included with ESD model), 0" - 2.6" span	191025069E2
	MOUNTING OPTION: Wall bracket, 3" x 3"	308218109
	MOUNTING OPTION: Floor stand with casters, 25" diameter	US1043019
	MOUNTING OPTION: 1/2" pin mount adapter, 1.77" length	US0209022
	MOUNTING OPTION: 1/2" pin mount adapter, 3.75" length	US0209012
	ACCESSORY: Add-x lens, 4 diopters (2X)	190080019
	ACCESSORY: Add-x lens, 4d + 12d (2X + 4X)	190080029
	ACCESSORY: Add-x ESD lens, 4 diopters (2X)	190080049-00061280





**RING LED ACCESSORIES**

Item	Description	Part #
	MOUNTING OPTION: Universal base for table/wall, 2.4" x 2.4" (included)	204090019
	MOUNTING OPTION: Decorative table clamp (included with M10 model)	D14228000
	MOUNTING OPTION: Wall bracket for universal base, 2.4" x 2.8"	300213018-00025178
	MOUNTING OPTION: Magnetic base, 3.3" diameter	190057019-00015056
	MOUNTING OPTION: Table base for pin mount, 10" diameter	190186019-00009644
	MOUNTING OPTION: 1/2" Pin mount adapter, 1.77" length	US0209022
	MOUNTING OPTION: 1/2" Pin mount adapter. 3.75" length	US0209012

**TEVISIO ACCESSORIES**

Item	Description	Part #
	MOUNTING OPTION: Table clamp - with pin mount, 3.5" span (included),	19102506940
	MOUNTING OPTION: Wall bracket - heavy duty	226108019-00610754
	MOUNTING OPTION: Table clamp, ESD safe	190100029-00089021
	MOUNTING OPTION: 1/2" Pin mount adapter, 1.77" length	US0209022
	MOUNTING OPTION: 1/2" Pin mount adapter, 3.75" length	US0209012
	ACCESSORY: Add-x magnifier , 3.5 diopter (1.88X)	190208019-00575924
	ACCESSORY: Plug-In converter, 100-240 VAC w/quick disconnect	309414070-00555523

**ACANEO ACCESSORIES**

Item	Description	Part #
	MOUNTING OPTION: Ceiling bracket - fixed	337818010-00695171
	MOUNTING OPTION: Ceiling bracket - adjustable	337818020-00695174
	MOUNTING OPTION: Wall bracket	337763010-00682509
	MOUNTING OPTION: One-point suspension bracket kit with cables	226234019

## PART NUMBER INDEX

Part #	Page #	Part #	Page #
041803015-00080014	33	112545004-00011136	29
041803016-00006993	33	112545005-00011120	29
108210000-00055526	34	112545006-00011128	29
108620001-00013818	34	112545007-00011131	29
108670000-00081448	33	112545008-00011134	29
108670001-00081450	33	112545009-00011137	29
108670M00*	33	112545010-00011121	29
108670M01*	33	112545011-00011129	29
108680000-00081455	33	112545012-00011132	29
108680001-00081457	33	112545013-00011135	29
108680M00*	33	112545014-00011138	29
108680M01*	33	112560000-00003069	15
109033019-00014950	21	112560001-00003166	15
111410000-00057156	33	112560002-00006272	15
111410001-00057158	33	112560003-00006273	15
111420000-00057161	33	112571000-00084579	13
111420001-00057164	33	112571001-00085127	13
111440000-00057173	33	112571002-00085216	13
111440001-00057175	33	112571003-00085194	13
111450000-00064046	33	112571004-00085220	13
111450001-00057177	33	112571005-00085225	13
111650000-00063029	34	112571006-00085224	13
111650001	34	112571007-00085226	13
111690000-00063406	34	112571010-00085227	13
111690001-00063408	34	112571011-00085256	13
111720000-00059978	34	112571012-00085228	13
111720001-00059980	34	112571013-00085257	13
111730000-00059987	34	112571014-00085275	13
111730001-00059991	34	112571015-00085278	13
112153001-00083632	37	112571016-00085276	13
112153011-00083633	37	112571017-00085311	13
112353002-00058709	23	112571020-00079042	13
112353003-00058711	23	112571021-00082249	13
112369000-00084194	33	112571022-00082186	13
112369001-00084204	33	112571023-00082250	13
112370000-00084157	33	112571024-00082456	13
112370001-00084161	33	112571025-00082632	13
112385M10	23	112571026-00082511	13
112385M11	23	112571027-00082635	13
112385M20	23	112571031-00082840	13
112385M21	23	112571032-00082820	13
112423000-00071550	23	112571033-00082842	13
112423001-00071549	23	112571034-00082844	13
112544000-00001328	29	112571035-00082863	13
112544001-00011081	29	112571036-00082846	13
112544002-00011082	29	112571037-00082866	13
112544003-00011083	29	112573000-00499489	11
112544004-00011084	29	112573000-00608666	11
112544005-00011100	29	112573000-00608673	11
112544006-00011088	29	112573001-00514271	11
112544007-00011085	29	112574000-00499493	11
112544008-00011086	29	112574000-00608677	11
112544009-00011087	29	112574000-00608680	11
112544010-00011101	29	112574001-00511140	11
112544011-00011102	29	112576000-00562045	41
112544012-00011103	29	112576000-00562055	41
112544013-00011104	29	112576000-00562095	41
112544014-00011105	29	112576000-00562104	41
112545000-00001351	29	112577000-00562130	41
112545001-00011125	29	112577000-00562141	41
112545002-00011130	29	112577000-00562157	41
112545003-00011133	29	112577000-00562177	41

## PART NUMBER INDEX

Part #	Page #	Part #	Page #
112578000-00562192	41	113067000-00580633	7
112578000-00562207	41	113068000-00580636	7
112578000-00562219	41	113069000-00580639	7
112578000-00562228	41	113070000-00580642	7
112887024-00076049	27	113071000-00580645	7
112887027-00076050	27	113072000-00580648	7
112887034-00076059	27	113073000-00580651	7
112887037-00076065	27	113074000-00580654	7
112913010-00488729**	33	113075000-00580657	7
112913011-00488735**	33	113076000-00580660	7
112918000-00587322	53	113077000-00580663	7
112918000-00587326	53	113078000-00580666	7
112918000-00587329	53	113079000-00580669	7
112918000-00587332	53	113080000-00580672	7
112919000-00587335	53	113081000-00580675	7
112919000-00587338	53	113082000-00580681	7
112919000-00587341	53	113083000-00580684	7
112919000-00587344	53	113084000-00580690	7
112950000-00521546	37	113094000-00596722	11
112969000-00631173	43	113094000-00596788	11
112971000-00636165	43	113094000-00596791	11
112973000-00556029	43	113094000-00596794	11
112975000-00555619	43	113095000-00596761	11
112977000-00556183	43	113095000-00596803	11
112979000-00555677	43	113095000-00596806	11
112989000-00636407	43	113095000-00596809	11
112991000-00562401	41	113096000-00596764	11
112991000-00562464	41	113096000-00596857	11
112991000-00562476	41	113096000-00596862	11
112991000-00562486	41	113096000-00596870	11
112992000-00562495	41	113097000-00596767	11
112992000-00562510	41	113097000-00596874	11
112992000-00562522	41	113097000-00596877	11
112992000-00562543	41	113097000-00596880	11
112993000-00562556	41	113122000-00609807	7
112993000-00562567	41	113124000-00611855	7
112993000-00562589	41	113125000-00612844	7
112993000-00562598	41	113126000-00612973	7
113015000-00595377	53	113142000-00618824	55
113016000-00595384	53	113142M10	55
113045000-00580702	7	113155000-00646485	25
113046000-00580696	7	113155000-00669609	25
113047000-00580693	7	113161000-00660033	9
113048000-00580573	7	113161000-00662575	9
113049000-00580576	7	113161000-00662600	9
113050000-00580579	7	113162000-00660681	9
113051000-00580582	7	113162000-00662685	9
113052000-00580585	7	113162000-00662706	9
113053000-00580588	7	113163000-00660684	9
113054000-00580591	7	113163000-00662717	9
113055000-00580594	7	113163000-00662735	9
113056000-00580597	7	113164000-00660687	9
113057000-00580600	7	113164000-00662806	9
113058000-00580603	7	113164000-00662833	9
113059000-00580606	7	113178000-00672403	57
113060000-00580609	7	113178000-00689812	57
113061000-00580612	7	113181000-00680172	17
113062000-00580615	7	113181000-00680185	17
113063000-00580618	7	113182000-00680110	17
113064000-00580621	7	113182000-00680208	17
113065000-00580624	7	113183000-00680254	17
113066000-00580630	7	113183000-00680258	17

Machine

Task &amp; Workbench

Magnification &amp; Inspection

Facility Lighting

Accessories

## PART NUMBER INDEX

Part #	Page #	Part #	Page #
113184000-00680272	17	128130000-00084837	34
113184000-00680285	17	128130001	34
113185000-00668613	17	128150000-00084841	34
113185000-00680293	17	138450000-00019726	34
113231000-00682473	63	138450001-00019727	34
113231000 – EXTREME	63	138451000-00019665	34
113240000-00682500	63	138451001-00019672	34
113240000 – EXTREME	63	138462003-00020895	49
113259000-00641127	21	138491001-00488841	34
113259000-00641174	21	190007019-00014904	17, 19, 21, 23, 68, 71, 74
113260000-00641130	21	190015019-00014930	31, 35, 72, 73
113260000-00641177	21	190015719-00085498	31, 35, 72, 73
113261000-00641180	21	190015995	31, 35, 72, 73
113261000-00641183	21	190027019-00057337	31, 72
113279000-00641386	31	190033019-00014950	17, 19, 23, 49, 68, 71, 74, 75
113279000-00712020	31	190036109-00058238	23, 68
113280000-00641389	31	190057019-00015056	17, 21, 23, 55, 68, 71, 74, 77
113280000-00712023	31	190080019	49, 57, 75, 76
113281000-00641392	31	190080029	49, 57, 75, 76
113281000-00712026	31	190080049-00061280	57, 76
113282000-00641395	31	190100029-00089021	53, 77
113282000-00712029	31	190169719-00089351	31, 35, 72, 73
113283000-00641398	31	190180019-00092731	31, 35, 72, 73
113283000-00712032	31	190180719-00092730	31, 35, 72, 73
113284000-00641401	31	190181019-00092728	31, 35, 72, 73
113284000-00712036	31	190181719-00092729	31, 35, 72, 73
113347000-00692720	63	190182019-00078702	49, 75
113353000-00692743	63	190183019-00093961	31, 35, 72, 73
113389000-00692903	63	190186019-00009644	47, 49, 59, 74, 75, 76, 77
113398000-00692931	63	190186019 -00009644	55
113398000 – EXTREME	63	190207019-00575900	41, 75
113407000-00692959	63	190208019-00575924	53, 77
113407000 – EXTREME	63	19102506900	57, 76
113431000-00693029	63	19102506940	41, 53, 57, 75, 76, 77
113437000-00693051	63	191025069 40	49
113443000-00693069	63	191092019-00086727	37, 68
113458000-00699752	19	203081019-00019478	15, 68
113459000-00726434	57	204090019	23, 49, 55, 68, 75, 77
113459000-00726437	57	209582019-00048793	23, 68
113460000-00726444	57	209585019-00045202	23, 68
113460000-00726450	57	209585029	7, 9, 11, 13, 15, 17, 19, 21, 25, 27, 29, 31, 68, 69, 70, 71, 72, 74
113475000-00704990	45		
113476000-00704993	45	209585030	7, 9, 11, 13, 15, 27, 29, 31, 68, 69, 70, 71, 72, 74
113477000-00704996	45	209585032	7, 9, 11, 13, 15, 27, 29, 31, 68, 69, 70, 71, 72, 74
113513000-00722105	31	226108019-00610754	41, 49, 53, 75, 77
113514000-00722108	31	226234019	63, 77
113515000-00722111	31	300213018-00021578	19
113516000-00722114	31	300213018-00025178	17, 21, 23, 55, 68, 71, 74, 77
113517000-00722117	31	308218109	47, 57, 59, 74, 76
113518000-00722121	31	309361050-00092219	35, 73
113525000-00698859	59	309368010	35, 73
113686000-00753168	47	309414070-00555523	53, 77
128100000-00084831	34	309439010-00093716	35, 73
128100001-00084832	34	330603020-00002947	25, 68
128100900*	34	330690010-00577358	45
128100901*	34	337763010-00682509	63, 77
128110000-00084833	34	337818010-00695171	63, 77
128110900*	34	337818020-00695174	63, 77
128120000-00084835	34	408001015-00595587	11, 69
128120001-00084836	34	408001016-00595619	11, 69
128120900*	34	408001016	11, 69
128120901*	34	408001017-00595613	11, 69



## PART NUMBER INDEX

Part #	Page #
408001018-00595610	11, 69
408001019-00595616	11, 69
408001033-00514262	11, 69
408001034-00514265	11, 69
408001035-00514268	11, 69
408001037-00518121	11, 69
408001402-00671623	9, 70
408001403-00671626	9, 70
408001586-00578088	43, 75
408001875-00582072	7, 70
408001876-00582065	7, 70
408001878-00585535	7, 70
408109019-00728797	45, 76
450017020	35
450018010	35
450018182	37
450024M10	35
450024M12	35
450025020	35
450032020	35
450036013-00051081	35
450036190-00041493	49
450036222-00062234	49
450036M10	35, 49
450039012	35
450054012	35
619063010-00077590**	33
619063011-00005922**	33
D14228000	55, 59, 76, 77
ILL00100C-00050472	47, 74
SK0995719-00085652	31, 35, 72, 73
SK1021019-00010286	31, 35, 72, 73
SK1021719-00085499	31, 35, 72, 73
US0009001	7, 9, 70
US0009011	7, 9, 69, 70
US0009101	11, 69
US0009111	11
US0009201	7, 70
US0009211	7, 70
US0165012	31, 35, 72, 73
US0209012	41, 47, 49, 53, 55, 57, 74, 75, 76, 77
US0209022	41, 47, 49, 53, 55, 57, 74, 75, 76, 77
US1043019	57, 59, 74, 76
US1043019	47
VPR448000	65
VPR896000	65

Machine

Task &amp; Workbench

Magnification &amp; Inspection

Facility Lighting

Accessories

**HEADQUARTERS GERMANY**

Herbert Waldmann GmbH & Co. KG  
Peter - Henlein - Straße 5  
78056 VILLINGEN-SCHWENNINGEN  
GERMANY  
Telephone +49 7720 601 - 0  
Telephone +49 7720 601 - 100 (Sales)  
Fax +49 7720 601 - 290  
www.waldmann.com  
sales.germany@waldmann.com

**FRANCE**

Waldmann Eclairage S.A.S.  
Zone Industrielle  
Rue de l'Embranchement  
67116 REICHESTETT  
FRANCE  
Telephone +33 3 88 20 95 88  
Fax +33 3 88 20 95 68  
www.waldmann.com  
info-fr@waldmann.com

**ITALY**

Waldmann Illuminotecnica S.r.l.  
Via della Pace, 18 A  
20098 SAN GIULIANO MILANESE (MI)  
ITALY  
Telephone +39 02 98 24 90 24  
Fax +39 02 98 24 63 78  
www.waldmann.com  
info-it@waldmann.com

**THE NETHERLANDS**

Waldmann B.V.  
Lingewei 19  
4004 LK TIEL  
THE NETHERLANDS  
Telephone +31 344 631019  
Fax +31 344 627856  
www.waldmann.com  
info-nl@waldmann.com

**AUSTRIA**

Waldmann Lichttechnik Ges.m.b.H.  
Gewerbepark Wagram 7  
4061 PASCHING/LINZ  
AUSTRIA  
Telephone +43 7229 67400  
Fax +43 7229 67444  
www.waldmann.com  
info-at@waldmann.com

**SCANDINAVIA**

Waldmann Ljusteknik AB  
Skebokvarnsvägen 370  
124 50 BANDHAGEN  
SWEDEN  
Telephone +46 8 990 350  
Fax +46 8 991 609  
www.waldmann.com  
info-se@waldmann.com

**SWITZERLAND**

Waldmann Lichttechnik GmbH  
Benkenstrasse 57  
5024 KÜTTIGEN  
SWITZERLAND  
Telephone +41 62 839 1212  
Fax +41 62 839 1299  
www.waldmann.com  
info-ch@waldmann.com

**UNITED KINGDOM**

Waldmann Lighting Ltd.  
10 Millfield House  
Croxley Park  
WATFORD WD18 8YX  
UNITED KINGDOM  
Telephone +44 1923 800030  
Fax +44 1923 800016  
www.waldmann.com  
info-uk@waldmann.com

**USA**

Waldmann Lighting Company  
9 W. Century Drive  
WHEELING, ILLINOIS 60090  
USA  
Telephone +1 847 520 1060  
Fax +1 847 520 1730  
www.waldmannlighting.com  
waldmann@waldmannlighting.com

**CHINA**

Waldmann Lighting (Shanghai) Co., Ltd.  
Part A11a, No. Five Normative Workshop  
199 Changjian Road, Baoshan  
SHANGHAI, P.R.C. 200949  
CHINA  
Telephone +86 21 5169 1799  
Fax +86 21 3385 0032  
www.waldmann.com.cn  
info-cn@waldmann.com

**SINGAPORE**

Waldmann Lighting Singapore Pte. Ltd.  
77A Neil Road  
SINGAPORE 088903  
SINGAPORE  
Telephone +65 6275 8300  
Fax +65 6275 8377  
www.waldmann.com  
sales-sg@waldmann.com