

**SUBMITTAL DRAWING**  
**22' CONTINUOUS RUN PENDANT**

**PROJECT**

**AGENCY**

**DISTRIBUTOR**

**NOTES**

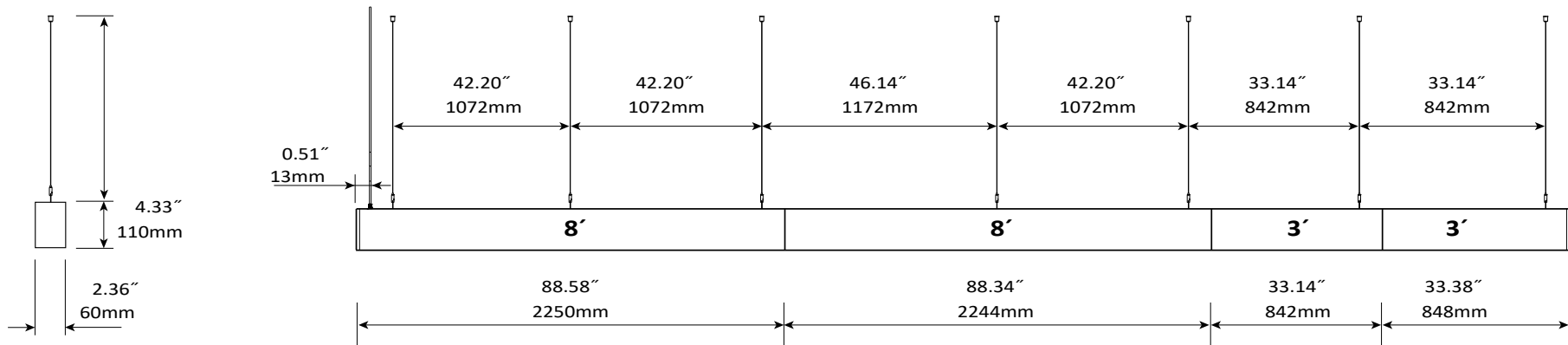

**TYPE**

**ORDER CONFIGURATION**

**QUANTITY**

(See Spec Sheet)

\* For Emergency Fixtures Mark Above with EM