

SUBMITTAL DRAWING
14' CONTINUOUS RUN PENDANT

PROJECT

AGENCY

DISTRIBUTOR

NOTES

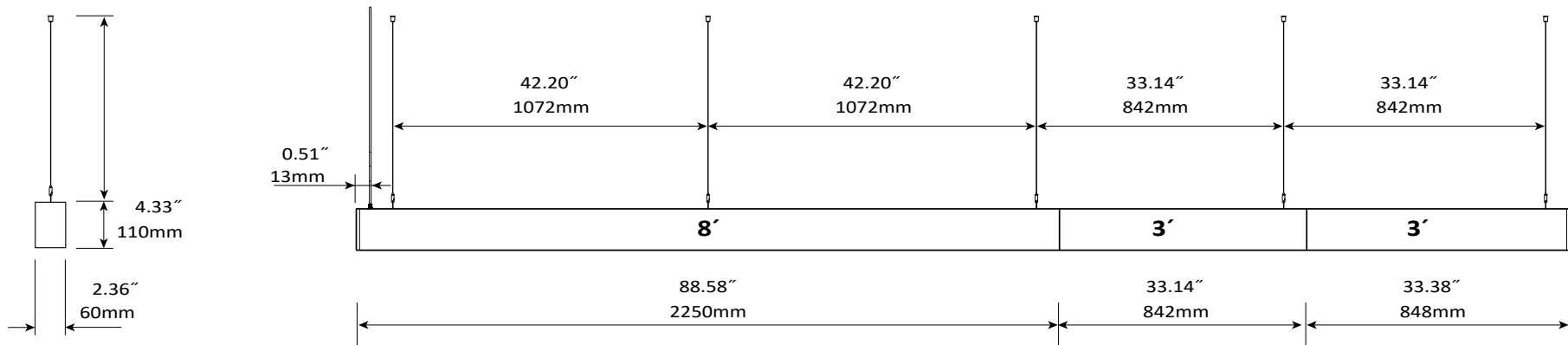

TYPE

ORDER CONFIGURATION

QUANTITY

(See Spec Sheet)

* For Emergency Fixtures Mark Above with EM