

light source
work equipment
connected load
Power consumption
luminous flux
luminous efficacy
light distribution
color temperature
color rendering index (CRI)
glare control
System of protection
class of protection
technology
operation
luminaire body

lamp cover
weight (net)
mains supply

design
Fastening
dimension

special features

LED
Energy efficiency category A/A+/A++
without
22-26 V; DC
approx. 25 W
approx. 3150 lm
approx. 126 lm/W
direct
neutral white, approx. 5000 K
>= 80
screen
IP54
III
multi-stage switchable
external
aluminium/plastic, anodised; painted, aluminium coloured
anodised
Acrylic satine
approx. 0.8 kg (1.76lb)
built-in plug
M12-A-5
mounted version
bracket
A=1455mm, C=1410mm, C1=1440mm
A=57.2 in, C= 55.5 in, C1=56.6 in
ADVANCED package, through-wired



illuminance

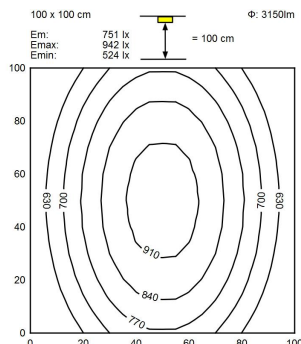

luminous intensity

