

light source  
 work equipment  
 connected load  
 Power consumption  
 luminous flux  
 luminous efficacy  
 light distribution  
 color temperature  
 color rendering index (CRI)  
 glare control  
 System of protection  
 class of protection  
 technology  
 operation  
 luminaire body

lamp cover  
 weight (net)  
 mains supply

design  
 Fastening  
 dimension

special features

LED  
 Energy efficiency category A/A+/A++  
 without  
 22-26 V; DC  
 approx. 15 W  
 approx. 1890 lm  
 approx. 126 lm/W  
 direct  
 neutral white, approx. 5000 K  
 >= 80  
 screen  
 IP54  
 III  
 multi-stage switchable  
 external  
 aluminium/plastic, anodised; painted, aluminium coloured  
 anodised  
 Acrylic satine  
 approx. 0.5 kg (1.1 lb)  
 built-in plug  
 M12-A-5  
 mounted version  
 bracket  
 A=895mm, C=850mm, C1=880mm  
 A=35.2 in, C= 33.4 in, C1=34.6 in  
 ADVANCED package, through-wired



illuminance

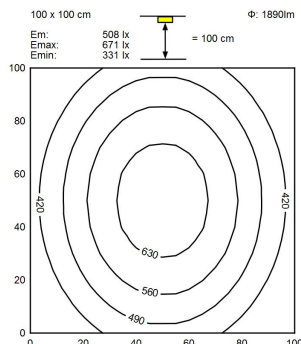

luminous intensity

