

PROJECT:		TYPE:		QUANTITY	
-----------------	--	--------------	--	-----------------	--

Electrical:

Nominal input voltage	100-240V
Frequency range	50 / 60Hz
Power consumption	30W (42-52VA)
Input current	0.42A
Integrated electronic transformer	24V DC output
Approval - Safety	ETL/cETL
User interface	Continuously dimmable rotary switch on the head



Illumination:

Fitted with	LED Technology
Central illuminance at 1.0m	60,000 lux
Light field diameter d10 at 1.0m	Ø = 16 cm (6.3in)
Light field diameter d50 at 1.0m	Ø = 8.5 cm (3.3in)
Depth of illumination L1 + L2	120cm (47.24in)
Color Temperature	4500 K
Color Rendering Index Ra	>95
Life time	40000h

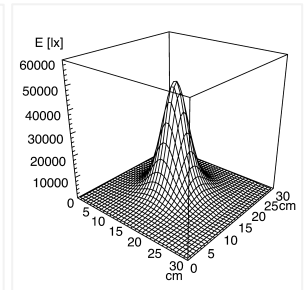
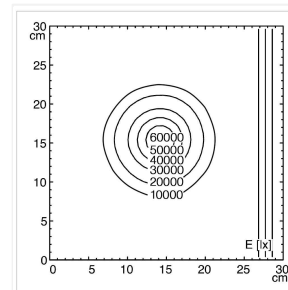

Weight:

Light head	3 kg (6.6lbs)
triango 30 C (includes light head)	15 kg (33lbs)
Luminaire Materials	Head – polycarbonate & acrylonitrile butadiene styrene copolymer (PC &ABS); Arm – metal
Fastening	Ceiling mount to structural ceiling, tube can be field cut to length (150-900 mm)

Classification:

triango 30	Class I; FDA Class I
Degree of protection as per IEC 529	IP 20
Light head	IP 43 (horizontal position)
Electrical safety test according to:	AAMI ES60601-1, CSA C22.2#60601-1, IEC/EN 60601-1, IEC/EN 60601-2-41, IEC/EN 60601-1-2
Special feature	Removable Sterilizable Handle included

Component List - Included

#	Part Number	Description
1	US4-002-150	Mounting Plate 11.5 in.
2	D74-285-000	Dome Cover
3	US4-001-310	Pole, 500MM Length
4	D74-544-100	Spring Balanced Arm
5	D15-312-000	Head, Triango 30, 24V, LED
6	US4-002-414	Dome Cover Kit w/ Collar
7	US4-002-415	Disc Cover Kit w/ Collar

Additional Information Available (Manuals)

1	Call Factory	Triango Pre-Install Guide
2	Included	Triango Manual
3	Call Factory	Triango Spare Parts Manual

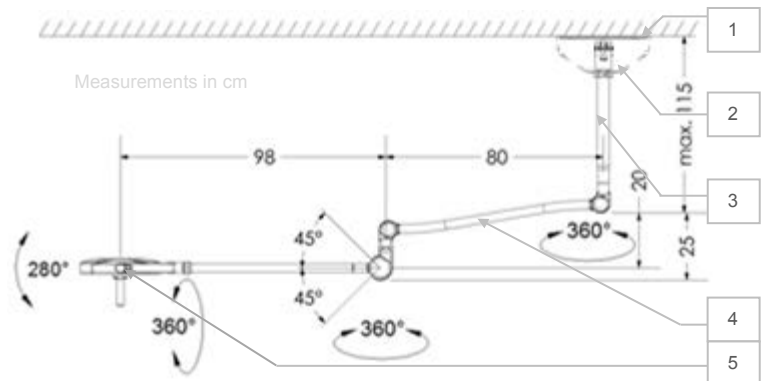

NOTE: If fixture is to be installed above a drop ceiling, Additional items 6 or 7 must be ordered separately. Please refer to Triango Pre-Install Guide for installation suggestions.